

X-800C® High-Power Cinema Subwoofer



***Keep these important operating instructions.  
Check [www.meyersound.com](http://www.meyersound.com) for updates.***

---

© 2012, 2021

Meyer Sound. All rights reserved.

X-800C Operating Instructions, PN 05.087.011.01 A2

The contents of this manual are furnished for informational purposes only, are subject to change without notice, and should not be construed as a commitment by Meyer Sound Laboratories Inc. Meyer Sound assumes no responsibility or liability for any errors or inaccuracies that may appear in this manual. Except as permitted by applicable copyright law, no part of this publication may be reproduced, stored in a retrieval system, or transmitted, in any form or by any means, electronic, mechanical, recording or otherwise, without prior written permission from Meyer Sound.

The following is a partial list of Meyer Sound trademarks and service marks:





650-P®, 650-R2®, Acheron®, AlignALink, B-Noise, Bluehorn, BroadbandQ®, CAL, Callisto®, Compass®, Compass Go by Meyer Sound, Compass RMS, Composite EQ, Constellation®, CueConsole, CueStation, D-Mitri®, EXP®, Galileo®, GuideALink, Intelligent AC, LCS, LEO®, LEO-M, LEOPARD, LYON, M Series, M1D, M2D, M3D, MAPP, MAPP Online Pro®, MAPP 3D, MAPP XT, Matrix3, MatrixLink, M'elodie®, MICA®, MILO®, MINA, MSL-4®, MultiSense, QuickFly®, QuietCool, REM®, RMS, SIM®, Spacemap®, SpeakerSense, Stella, Thinking Sound®, TM Array, TruPower®, TruShaping®, UltraSeries, U-Shaping®, VariO, VRAS, Wild Tracks.

All third-party trademarks mentioned herein are the property of their respective trademark holders.

## IMPORTANT SAFETY INSTRUCTIONS

These symbols indicate important safety or operating features in this booklet and on the frame or chassis:

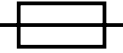
### SYMBOLS USED

				
<b>Dangerous voltages: risk of electric shock</b>	<b>Important operating instructions</b>	<b>Replaceable Fuse</b>	<b>Protective earth ground</b>	<b>Hot surface: do not touch</b>
<b>Gefährliche Spannungen: Stromschlaggefahr</b>	<b>Hinweis auf wichtige Punkte der Betriebsanleitung</b>	<b>Austauschbare Sicherung</b>	<b>Schutzerde</b>	<b>Heiße Oberfläche: nicht berühren</b>
<b>Pour indiquer les risques résultant de tensions dangereuses</b>	<b>Instructions d'utilisation importantes</b>	<b>Fusible remplaçable</b>	<b>Terre de protection</b>	<b>Surface chaude: ne pas toucher</b>
<b>Para indicar voltajes peligrosos</b>	<b>Instrucciones importantes de funcionamiento y/o Mantenimiento</b>	<b>Fusible reemplazable</b>	<b>Toma de tierra de protección</b>	<b>Superficie caliente: no tocar</b>

1. Read these instructions.
2. Keep these instructions.
3. Heed all warnings.
4. Follow all instructions.
5. Do not use this apparatus near water.
6. Clean only with dry cloth.
7. Do not block any ventilation openings. Install in accordance with Meyer Sound's installation instructions.
8. Do not install near any heat sources such as radiators, heat registers, stoves, or other apparatus that produce heat.
9. Do not defeat the safety purpose of the grounding-type plug. A grounding type plug has two blades and a third grounding prong. The third prong is provided for your safety. If the provided plug does not fit into your outlet, consult an electrician for replacement of the obsolete outlet.
10. Protect the power cord from being walked on or pinched, particularly at plugs, convenience receptacles, and the point where they exit from the apparatus. The AC mains plug or appliance coupler shall remain readily accessible for operation.
11. Only use attachments/accessories specified by Meyer Sound.
12. Use only with the caster rails or rigging specified by Meyer Sound, or sold with the apparatus. Handles are for carrying only.
13. Unplug this apparatus during lightning storms or when unused for long periods of time.
14. If equipped with an external fuse holder, the replaceable fuse is the only user-serviceable item. When replacing the fuse, only use the same type and the same value.
15. Refer all other servicing to qualified service personnel. Servicing is required when the apparatus has been damaged in any way, such as when the power-supply cord or plug has been damaged; liquid has been spilled or objects have fallen into the apparatus; rain or moisture has entered the apparatus; the apparatus has been dropped; or when for undetermined reasons the apparatus does not operate normally.

 **WARNING:** To reduce the risk of fire or electric shock, do not expose this apparatus to rain or moisture. Do not install the apparatus in wet or humid locations without using weather protection equipment from Meyer Sound.

 **WARNING:** Class I apparatus shall be connected to a mains socket outlet with a protective earthing connection.

 **CAUTION:** Disconnect the mains plug before disconnecting the power cord from the loudspeaker.

## English

- To reduce the risk of electric shock, disconnect the apparatus from the AC mains before installing audio cable. Reconnect the power cord only after making all signal connections.
- Connect the apparatus to a two-pole, three-wire grounding mains receptacle. The receptacle must be connected to a fuse or circuit breaker. Connection to any other type of receptacle poses a shock hazard and may violate local electrical codes.
- Do not install the apparatus in wet or humid locations without using weather protection equipment from Meyer Sound.
- Do not allow water or any foreign object to get inside the apparatus. Do not put objects containing liquid on or near the unit.
- To reduce the risk of overheating the apparatus, avoid exposing it to direct sunlight. Do not install the unit near heat-emitting appliances, such as a room heater or stove.
- If equipped with an external fuse holder, the replaceable fuse is the only item that can be serviced by the user. When replacing the fuse, only use the same type and value.
- This apparatus contains potentially hazardous voltages. Do not attempt to disassemble the unit. The only user-serviceable part is the fuse. All other repairs should be performed only by factory-trained service personnel.

## Deutsch

- Zur Minimierung der Gefahr eines elektrischen Schlages trennen Sie das Produkt vor dem Anschluss von Audio- und/oder Steuerleitungen vom Stromnetz. Das Netzkabel darf erst nach Herstellung aller Signalverbindungen wieder eingesteckt werden.
- Das Produkt an eine vorschriftsgemäss installierte dreipolige Netzsteckdose (Phase, Neutralleiter, Schutzleiter) anschließen. Die Steckdose muss vorschriftsgemäß mit einer Sicherung oder einem Leitungsschutzschalter abgesichert sein. Das Anschließen des Produkts an eine anders ausgeführte Stromversorgung kann gegen Vorschriften verstossen und zu Stromunfällen führen.
- Das Produkt nicht an einem Ort aufstellen, an dem es direkter Wassereinwirkung oder übermäßig hoher Luftfeuchtigkeit ausgesetzt werden könnte, solange es sich nicht um ein Produkt handelt, dass mit der Meyer Sound Weather Protection Option ausgestattet ist.
- Vermeiden Sie das Eindringen von Wasser oder Fremdkörpern in das Innere des Produkts. Stellen Sie keine Objekte, die Flüssigkeit enthalten, auf oder neben dem Produkt ab.
- Um ein Überhitzen des Produkts zu verhindern, halten Sie das Gerät von direkter Sonneneinstrahlung fern und stellen Sie es nicht in der Nähe von wärmeabstrahlenden Geräten (z.B. Heizgerät oder Herd) auf.

- Bei Ausstattung mit einem externen Sicherungshalter ist die austauschbare Sicherung das einzige Gerät, das vom Benutzer gewartet werden kann. Verwenden Sie beim Austausch der Sicherung nur den gleichen Typ und Wert.
- Dieses Gerät enthält möglicherweise gefährliche Spannungen. Versuchen Sie nicht, das Gerät zu zerlegen. Der einzige vom Benutzer zu wartende Teil ist die Sicherung. Alle anderen Reparaturen dürfen nur von im Werk geschultem Servicepersonal ausgeführt werden.

## Français

- Pour éviter tout risque d'électrocution, débranchez l'enceinte de la prise secteur avant de mettre en place le câble audio. Ne rebranchez le cordon secteur qu'après avoir procédé à toutes les connexions de signal audio
- Brancher l'appareil sur une prise secteur à trois fils et deux pôles avec mise à la terre. La prise doit être reliée à un fusible ou à un disjoncteur. Le branchement à tout autre type de prise présente un risque de choc électrique et peut enfreindre les codes locaux de l'électricité.
- N'installez pas l'enceinte dans des endroits humides ou en présence d'eau sans utiliser d'équipements de protection adéquats fournis par Meyer Sound.
- Ne laissez pas d'eau ou d'objet étranger, quel qu'il soit, pénétrer à l'intérieur de l'enceinte. Ne posez pas d'objet contenant du liquide sur ou à proximité de l'enceinte.
- Pour réduire les risques de surchauffe, évitez d'exposer directement l'enceinte aux rayons du soleil. Ne l'installez pas à proximité de sources de chaleur, radiateur ou four par exemple.
- S'il est équipé d'un porte-fusible externe, le fusible remplaçable est le seul élément qui peut être réparé par l'utilisateur. Lors du remplacement du fusible, n'utilisez que le même type et la même valeur.
- Cet appareil contient des tensions potentiellement dangereuses. N'essayez pas de démonter l'appareil. Le fusible est la seule pièce réparable par l'utilisateur. Toutes les autres réparations doivent être effectuées uniquement par du personnel de maintenance formé en usine.

## Español

- Para reducir el riesgo de descarga eléctrica, desconecte el aparato de la red eléctrica antes de instalar el cable de audio. Vuelva a conectar el cable de alimentación sólo después de realizar todas las conexiones de señal.
- Conecte el aparato a una toma de corriente de tres hilos y dos polos con conexión a tierra. El receptáculo debe estar conectado a un fusible o disyuntor. La conexión a cualquier otro tipo de receptáculo representa un riesgo de descarga eléctrica y puede violar los códigos eléctricos locales.

- No instale el aparato en lugares húmedos o mojados sin usar el equipo de protección contra intemperie de Meyer Sound.
- No permita que penetre agua u otros objetos extraños en el interior del aparato. No coloque objetos que contengan líquido sobre o cerca de la unidad.
- Para reducir el riesgo de sobrecalentamiento del aparato, evite exponerlo a la luz solar directa. No instale la unidad cerca de aparatos que emitan calor, como un calefactor o una estufa.
- Si está equipado con un portafusibles externo, el fusible reemplazable es el único elemento que puede ser reparado por el usuario. Cuando reemplace el fusible, use solamente el mismo tipo y valor.
- Este aparato contiene voltajes potencialmente peligrosos. No intente desmontar la unidad. La única pieza que el usuario puede reparar es el fusible. Todas las demás reparaciones deben ser realizadas únicamente por personal de servicio capacitado de fábrica.



---

# CONTENTS

<b>Important Safety Instructions</b>	<b>iii</b>
Symbols Used	iii
<b>Chapter 1: Introduction</b>	<b>1</b>
How to Use This Manual	1
X-800C Cinema Subwoofer	1
<b>Chapter 2: Power Requirements</b>	<b>3</b>
AC Connector	3
AC Power Distribution	3
X-800C Voltage Requirements	4
X-800C Current Requirements	4
Powering Up the X-800C	5
Electrical Safety Guidelines	5
<b>Chapter 3: Amplification and Audio</b>	<b>7</b>
Audio Connectors	7
Limiting	8
Input Polarity Switch	9
Amplifier Cooling System	9
<b>Chapter 4: X-800C RMS Remote Monitoring System</b>	<b>11</b>
Compass RMS Software	11
RMS Module	11
Resetting the RMS Module	12
<b>Chapter 5: System Design and Integration Tools</b>	<b>13</b>
MAPP System Design Tool	13
Galileo GALAXY Network Platform	14
<b>Appendix A: X-800C Specifications</b>	<b>15</b>
Acoustical, Electrical, Physical and Environmental Specifications	15
X-800C Compliance	17
X-800C Dimensions	17





## CHAPTER 1: INTRODUCTION

### HOW TO USE THIS MANUAL

Please read these instructions in their entirety before configuring a Meyer Sound loudspeaker system. In particular, pay close attention to material related to safety issues.

As you read these instructions, you will encounter the following icons for notes, tips, and cautions:



**NOTE:** A note identifies an important or useful piece of information relating to the topic under discussion.



**TIP:** A tip offers a helpful tip relevant to the topic at hand.



**CAUTION:** A caution gives notice that an action may have serious consequences and could cause harm to equipment or personnel, or could cause delays or other problems.

Information and specifications are subject to change. Updates and supplementary information are available at [meyersound.com](http://meyersound.com).

Meyer Sound Technical Support is available at:

- **Tel:** +1 510 486.1166 (Monday through Friday 9:00 am to 5:00 pm PST)
- **Tel:** +1 510 486.0657 (after hours support)
- **Web:** [meyersound.com/support](http://meyersound.com/support)

### X-800C CINEMA SUBWOOFER

The X-800C cinema subwoofer boosts low-frequency headroom in Meyer Sound cinema installations. The linear, self-powered X-800C offers low-frequency output down to 20 Hz with clean, punchy transients, and provides excellent phase coherence for smooth transitions between screen channels and LFE channels.

The X-800C includes two Meyer Sound long-excursion, high-efficiency 18-inch drivers housed in an optimally tuned, vented cabinet. Output rolls off well below 250 Hz, avoiding any adverse comb filtering effects from the proximity of the dual drivers.



*X-800C Cinema Subwoofer*

The drivers are powered by a two-channel class AB/H amplifier with complementary MOSFET output stages. A total output of 1240 Watts ensures the system has ample headroom to accommodate the lowest frequencies of the most extreme digital soundtracks.

Each amplifier channel features TruPower® limiting to maximize loudspeaker reliability, minimize power compression, and extend component life. The Intelligent AC™ power supply affords automatic voltage selection, EMI filtering, soft current turn-on, and surge suppression.

A laser-trimmed differential input with high common-mode rejection enables long line-level signal runs with shielded, twisted-pair cable. As with all Meyer Sound self-powered loudspeakers, processing correction filters for flat phase and frequency responses.

Integration of the X-800C within Meyer Sound cinema installations is easily achieved with the MAPP System Design Tool (see [meyersound.com/products](http://meyersound.com/products) for more details).



*Meyer Sound Cinema Loudspeakers: X-800C Subwoofer, Acheron Screen Channel Loudspeakers, and HMS-10 Surround Loudspeaker*

Meyer Sound's optional RMS™ remote monitoring system provides comprehensive monitoring of system parameters on a Windows®-based computer.

The X-800C cabinet is constructed of premium birch plywood and coated with a durable, medium-gloss, smooth black finish. A textured finish is optionally available.

## CHAPTER 2: POWER REQUIREMENTS

The X-800C subwoofer combines advanced loudspeaker technology with equally advanced power capabilities. Understanding power distribution, voltage and current requirements, and electrical safety guidelines is critical to the safe operation of the X-800C.

### AC CONNECTOR

The X-800C AC connector supplies AC power to the unit and is located on its rear user panel. The X-800C can be equipped with either a NEMA L6-20 (twistlock) male inlet or IEC 309 male inlet.

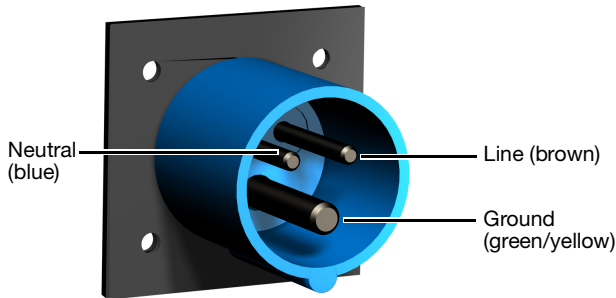

*NEMA L6-20 (Twistlock) Male Inlet*

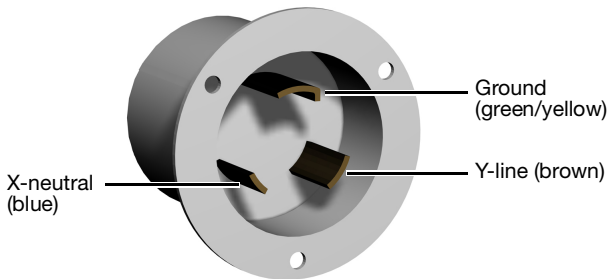

*IEC 309 Male Inlet Connector*

The X-800C requires a grounded outlet. To operate safely and effectively, it is extremely important that the entire system be properly grounded.

If the included AC power cable is replaced, make sure to use a cable that is wired correctly and equipped with the with the appropriate power plug (on the other end) for the area in which the unit will operate.

### AC Connector Wiring

When wiring international or special-purpose AC power cables and connectors, use the following wiring scheme:

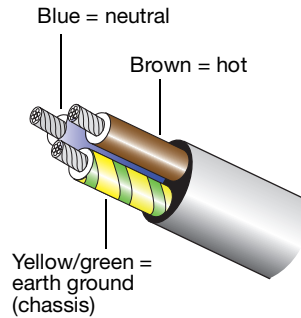

*AC Cable Color Code*

- Connect the blue wire to the black terminal, or the terminal marked with an N.
- Connect the brown wire to the red terminal, or the terminal marked with an L.
- Connect the yellow and green wire to the green (or green and yellow) terminal, or the terminal marked with an E.

**CAUTION:** When creating AC power cables and distribution systems, it is important to preserve AC line polarity and connect the earth ground on both ends of the cable. The X-800C requires a grounded connection. Always use a grounded outlet and plug. It is extremely important that the system be properly grounded to operate safely and properly. Do not ground-lift the AC cable.

### AC POWER DISTRIBUTION

All components in an audio system (self-powered loudspeakers, mixing consoles, and processors) must be properly connected to an AC power distribution system, ensuring that AC line polarity is preserved and that all grounding points are connected to a single node or common point using the same cable gauge as the neutral and line cables.

**NOTE:** Improper grounding of connections between loudspeakers and the rest of the audio system may produce noise or hum, or cause serious damage to the input and output stages of the system's electronic components.

**CAUTION:** Before applying AC power to any Meyer Sound self-powered loudspeaker, make sure that the voltage potential difference between the neutral and earth-ground lines is less than 5 V AC.

The figure below illustrates a basic three-phase AC distribution system with the loudspeaker load distributed across the three phases. All loudspeakers are connected to common neutral and earth-ground lines.

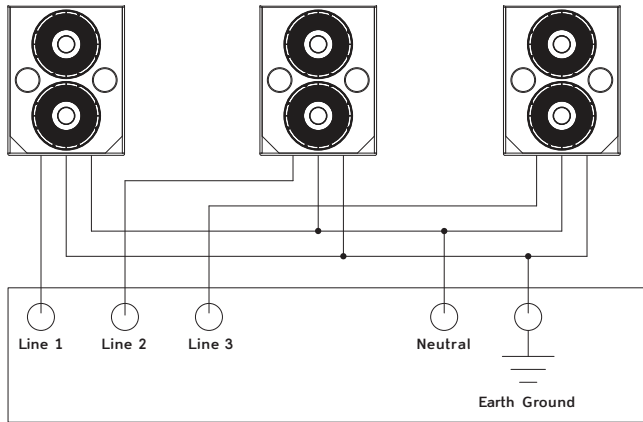

AC Power Distribution System

### X-800C VOLTAGE REQUIREMENTS

The X-800C operates safely and continuously when the AC voltage stays within 85–134 V AC and 165–264 V AC at 50 or 60 Hz. The subwoofer allows any combination of voltage to GND (neutral-line-ground or line-line-ground).

If the voltage drops below 85 V (brownout), the X-800C uses stored power to continue operating temporarily; the subwoofer shuts down if the voltage does not rise above the low boundary before the stored power is used.

If the voltage rises above 275 V, the power supply could become damaged.

**CAUTION:** The power source for the X-800C should always operate within the required voltage range, at least a few volts from the upper and lower ranges. This will ensure that AC voltage variations from the service entry — or peak voltage drops due to cable runs — will not cause the loudspeaker’s amplifier to cycle on and off or cause damage to the power supply.

**TIP:** Because the X-800C does not require a dedicated neutral line, and it can tolerate elevated voltages from the ground line, it can be connected to line-line terminals in 120 V, 3-phase Wye systems. This results in 208 V AC between lines

(nominal) and therefore draws less current than when using 120 V AC (line-neutral). Make sure that the voltage remains within the X-800C’s recommended operating windows (85–134 V AC and 165–264 V AC). The ground line must always be used for safety reasons and the line-to-ground voltage should never exceed 250 V AC (typically 120 V AC from line-to-ground).

### X-800C CURRENT REQUIREMENTS

The current draw for the X-800C is dynamic and fluctuates as operating levels change. Since different cables and circuit breakers heat up at varying rates, it is important to understand the following types of current ratings and how they affect circuit breaker and cable specifications.

- **Idle Current** — The maximum rms current during idle periods.
- **Maximum Long-Term Continuous Current** — The maximum rms current during a period of at least 10 seconds. The Maximum Long-Term Continuous Current is used to calculate temperature increases for cables, to ensure that cable sizes and gauges conform to electrical code standards. The current rating is also used as a rating for slow-reacting thermal breakers.
- **Burst Current** — The maximum rms current during a period of around one second. The Burst Current is used as a rating for magnetic breakers. It is also used for calculating the peak voltage drop in long AC cable runs according to the following formula:  
 $V_{pk}(\text{drop}) = I_{pk} \times R(\text{cable total})$
- **Maximum Instantaneous Peak Current** — A rating for magnetic breakers.
- **Inrush Current** — The spike of initial current encountered when powering on.

Use Table 1 as a guide for selecting cable gauge and circuit breaker ratings for the system’s operating voltage.

Table 1: X-800C Current Draw

Current Draw	115 V AC	230 V AC	100 V AC
Idle Current	0.64 A rms	0.32 A rms	0.85 A rms
Maximum Long-Term Continuous Current	8 A rms	4 A rms	10 A rms
Burst Current	15 A rms	8 A rms	18 A rms
Maximum Instantaneous Peak Current	22 A peak	11 A peak	25 A peak
Inrush Current	<7 A peak	<7 A peak	10 A peak

The minimum electrical service amperage required by an X-800C subwoofer system is the sum of the Maximum Long-Term Continuous Current for each subwoofer. An additional 30 percent above the minimum amperage is recommended to prevent peak voltage drops at the service entry.

 **NOTE:** For best performance, the AC cable voltage drop should not exceed 10 V, or 10 percent at 115 V and 5 percent at 230 V. Make sure that even with AC voltage drops that the AC voltage always remains within the operating windows.

## POWERING UP THE X-800C

When AC power is applied to the X-800C its Intelligent AC™ power supply automatically selects the correct operating voltage, allowing it to be used internationally without manually setting voltage switches. In addition, Intelligent AC suppresses high-voltage transients up to several kilovolts, filters common mode and differential mode radio frequencies (EMI), and sustains operation temporarily during low-voltage periods.

When powering up the X-800C, the following startup events take place over several seconds.

1. Audio output is muted.
2. Voltage is detected and the power supply mode is automatically adjusted as necessary.
3. The primary fan turns on.
4. The power supply ramps up.
5. The green Active LED on the user panel lights up, indicating the subwoofer is ready to output audio.

 **CAUTION:** If the Active LED does not light up, or the X-800C does not output audio after ten seconds, remove AC power immediately and verify that the voltage is within the required range. If the problem persists, contact Meyer Sound Technical Support.

 **CAUTION:** If either of the X-800C's circuit breakers trip (the white center buttons disengage), do NOT reset and reapply power. Disconnect the AC power and contact Meyer Sound Service Department for instructions on how to proceed.

## ELECTRICAL SAFETY GUIDELINES

Pay close attention to these important electrical and safety guidelines.

- The X-800C requires a grounded outlet. Always use a grounded outlet and plug.

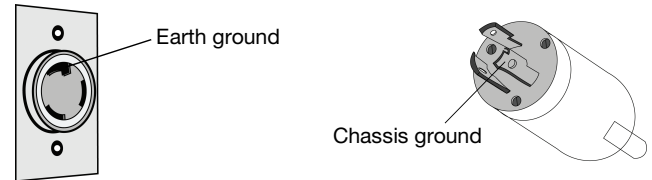

- Do not use a power cord adapter to drive the X-800C from a standard three-prong Edison outlet, since that connector is only rated for 15 A (NEMA 5-15R, 125 V AC maximum).

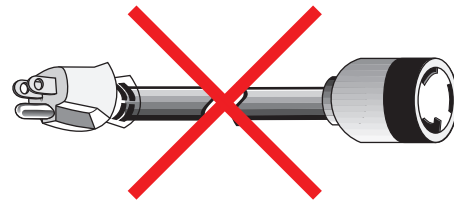

- Make sure the AC power cable for the loudspeaker has the appropriate power plug (on the other end) for the area in which the loudspeaker will operate.
- Do not operate the unit if the power cable is frayed or broken.
- Keep all liquids away from the X-800C to avoid hazards from electrical shock.



## CHAPTER 3: AMPLIFICATION AND AUDIO

The low-frequency drivers in the X-800C are powered by a two-channel proprietary Meyer Sound amplifier with MOSFET output stages. The audio signal is processed with an electronic crossover, correction filters for phase and frequency response, and driver protection circuitry. Each channel has peak and rms limiters that prevent driver over-exursion and regulate the temperature of the voice coil.

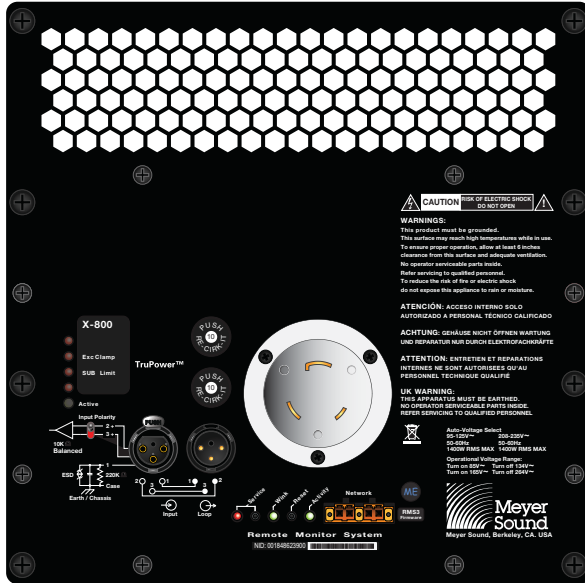

X-800C Rear Panel (with NEMA L6-20 AC Connector)

The X-800C rear panel includes audio connectors for Input and Loop output, as well as an Input Polarity switch. The X-800C is also available with an optional RMS module (see Chapter 4, “RMS Remote Monitoring System”).

## AUDIO CONNECTORS

The X-800C include female XLR Input and male XLR Loop output connectors.

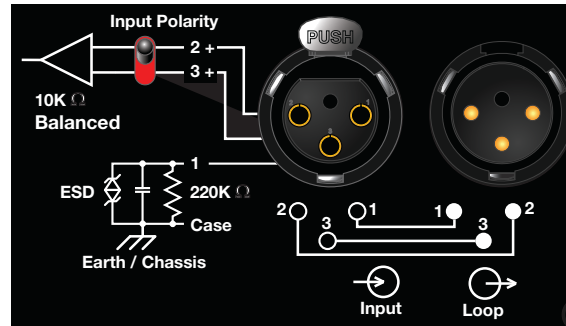

X-800C Audio Connectors, Input and Loop Output

## Input Connector

The female XLR Input connector accepts a balanced audio signal with an input impedance of 10 kOhm. The connector uses the following wiring:

- **Pin 1** — 220 kOhm max to chassis and earth ground (ESD clamped)
- **Pin 2** — Signal (+)
- **Pin 3** — Signal (-)
- **Case** — Earth (AC) ground and chassis

Pins 2 and 3 carry the input as a differential signal. Pin 1 is connected to earth through a 220 kOhm, 1000 pF, 15 V clamped network. This circuitry provides virtual ground lift for audio frequencies while allowing unwanted signals to bleed to ground. Make sure to use standard, balanced XLR audio cables with all three pins connected on both ends. Telescopic grounding is not recommended, and shorting an input connector pin to the case may cause a ground loop, resulting in hum.

 **TIP:** If unwanted noise or hiss is produced by the loudspeaker, disconnect its input cable. If the noise stops, there is most likely nothing wrong with the loudspeaker. To locate the source of the noise, check the audio cable, source audio, and AC power.

## Loop Output Connector

The male XLR Loop output connector allows X-800C subwoofers to be looped from a single audio source. For applications that require multiple X-800Cs, connect the Loop output of the first unit to the Input of the second, and so forth.



**NOTE:** The order in which loudspeakers are connected when looping audio signals is unimportant. The Loop connector is wired in parallel to the Input connector and transmits the unbuffered source signal even when the X-800C is powered off.

To avoid distortion when looping multiple X-800Cs, make sure the source device can drive the total load impedance of the looped loudspeakers. In addition, the source device must be capable of delivering approximately 20 dBV (10 V rms into 600 ohms) to yield the maximum peak SPL over the entire operating bandwidth of the loudspeakers. Most professional audio equipment can transmit these source levels.

To calculate the load impedance for the looped loudspeakers, divide 10 kOhms (the input impedance for a single X-800C) by the number of looped loudspeakers. For example, the load impedance for 10 X-800C loudspeakers is 1000 ohms (10 kOhms / 10). To drive this number of looped loudspeakers, the source device should have an output impedance of 100 ohms or less. This same rule applies when looping X-800C loudspeakers with other self-powered Meyer Sound loudspeakers and subwoofers.



**NOTE:** Most source devices are capable of driving loads no smaller than 10 times their output impedance.



**CAUTION:** Make sure that all cabling for looped loudspeakers is wired correctly (Pin 1 to Pin 1, Pin 2 to Pin 2, and so forth) to prevent the polarity from being reversed. If one or more loudspeakers in a system have reversed polarity, frequency response and coverage will be significantly degraded.

## LIMITING

The X-800C employs Meyer Sound's advanced TruPower® limiting. Conventional limiters assume a constant loudspeaker impedance and set the limiting threshold by measuring voltage alone. This method is inaccurate because loudspeaker impedances change as frequency content in the source material changes, and as thermal values for the loudspeaker's voice coil and magnet vary. Consequently,

conventional limiters often begin limiting prematurely, which reduces system headroom and dynamic range.

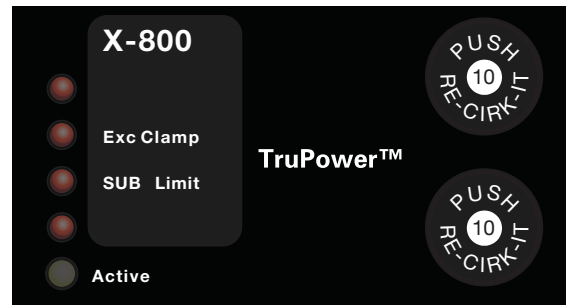

X-800C Limit LEDs

In contrast, TruPower limiting anticipates varying loudspeaker impedances by measuring both current and voltage to compute the actual power dissipation in the voice coil. This improves performance, both before and during limiting, by allowing the driver to produce the maximum SPL across its entire frequency range. TruPower limiting also eliminates power compression at high levels over lengthy periods, which helps regulate voice coil temperatures, thereby extending the life of the driver.



**NOTE:** Since TruPower limiting only reduces signal levels to keep voice coil temperatures under a safe margin, signal peaks remain unaffected.

## Sub Limit LED

The two low-frequency drivers for the X-800C are powered by separate amplifier channels that are routed to a single limiter. When a safe power level is exceeded in either channel, limiting is engaged for both channels and the SUB Limit LED lights.

When engaged, the limiter not only protects the drivers but also prevents signal peaks from causing excessive distortion in the amplifier channels, thereby preserving headroom and maintaining smooth frequency responses at high levels. When levels return to normal, below the limiter thresholds, limiting ceases.

The X-800C performs within its acoustical specifications at normal temperatures when the SUB Limit LED is unlit, or if the LED is lit for two seconds or less and then turns off for at least one second. If the LED remains lit for longer than three seconds, the loudspeaker enters hard limiting where:



- Increases to the input level have no effect.
- Distortion increases due to clipping and nonlinear driver operation.
- The drivers are subjected to excessive heat and excursion, which will compromise their life span and may eventually lead to damage over time.

**CAUTION:** The SUB Limit LEDs indicates when a safe, optimum level is exceeded. If an X-800C begins to limit before reaching the required SPL, consider adding more subwoofers to the system.

**NOTE:** The X-800C subwoofer uses an optical limiter that adds no noise and has no effect on the signal when the limiter is not engaged and the SUB Limit LED is not lit.

## Excursion Clamp LED

The X-800C drivers are protected from over-excursion by an Excursion Clamping circuit, indicated by the Exc Clamp LED. The circuit does not have attack or release time constants and provides instantaneous braking for the drivers without the pumping effects commonly exhibited by compressors and limiters.

The Excursion Clamping circuit uses sophisticated filters to minimize the distortion normally caused by clamping and clipping. As the X-800C's input signal is increased beyond the clamping point, the output signal remains at a fixed level, protecting the drivers and minimizing negative sonic effects. The X-800C operates normally and safely when the Exc Clamp LED is on for no longer than two seconds, and off for at least one second.

## INPUT POLARITY SWITCH

The X-800C includes an Input Polarity switch on its rear panel that toggles the polarity of the source signal. When the switch is in the UP position, pin 2 is hot relative to pin 3, resulting in a positive pressure wave when a positive signal is applied to pin 2. When the switch is in the DOWN position, pin 3 is hot relative to pin 2, resulting in a positive pressure wave when a positive signal is applied to pin 3.

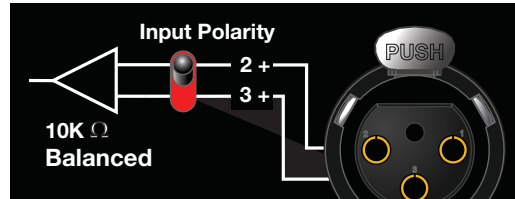

X-800C Input Polarity Switch

**NOTE:** The Input Polarity switch does not affect the signal coming from the Loop output connector. The Loop output connector is wired in parallel to the Input connector and transmits the unbuffered source signal (even when the loudspeaker is powered off).

## AMPLIFIER COOLING SYSTEM

The X-800C uses a forced-air cooling system with two fans (one variable-speed, ultra low-noise primary fan and one reserve fan) to prevent the amplifier module from overheating. The fans draw air in through ducts on the front of the cabinet, over the heat sink, and out the rear of the cabinet. Because dust does not accumulate in the amplifier circuitry, its life span is increased significantly.

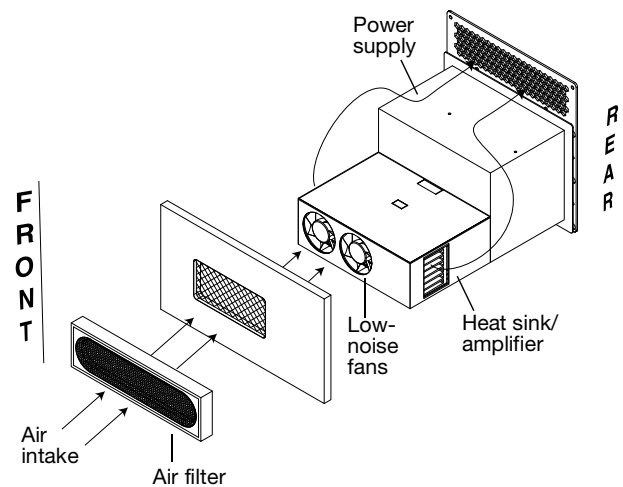

Airflow for the X-800C

**CAUTION:** To keep the X-800C from getting too hot, allow for proper ventilation, 6 inches, behind the loudspeaker.

When the X-800C heat sink temperature is below 42° C, the variable-speed primary fan runs continuously at its slowest speed with an inaudible operating noise. The primary fan increases speed when the heat sink temperature reaches 42° C; the primary fan reaches full speed at 62° C and is

barely audible near the cabinet, even without an audio signal. If the heat sink temperature reaches 74° C, the reserve fan turns on. The reserve fan turns on if:

- The primary fan has failed (check status immediately)
- High source levels are encountered for extended periods
- Dust has accumulated along the cooling path

The reserve fan turns off when the heat sink temperature lowers to 68° C.



**NOTE:** In the unlikely event that the reserve fan does not keep the X-800C heat sink temperature below 85° C, the unit automatically shuts down until AC power is removed and reapplied. If the X-800C shuts down again after cooling and re-applying AC power, contact Meyer Sound for repair information.

## Dust and the Amplifier Module

Operating the X-800C in dusty environments, or for prolonged, intensive periods, may cause dust to accumulate along its airflow path, thereby preventing normal cooling. Under these circumstances, it may be necessary to periodically remove the air intake foam and use compressed air to clear the dust from the foam and air ducts.

In addition, if the amplifier gets unusually hot, remove the amplifier module and use compressed air to clear any dust from its heat sink.





**CAUTION:** Make sure to unplug the AC power from the X-800C before cleaning its amplifier.

## CHAPTER 4: X-800C RMS REMOTE MONITORING SYSTEM

The X-800C loudspeaker optionally includes an RMS remote monitoring system module, allowing it to be connected to an RMS network. RMS reports, in real time, the status and power usage of multiple Meyer Sound loudspeakers from a Mac® or Windows®-based computer. The RMsServer™ communicates with Meyer Sound loudspeakers equipped with RMS modules. RMsServer is a compact, Ethernet-based hardware unit with two FT-10 RMS data ports. RMsServer stores system configurations internally, eliminating most manual data entry. Systems can be monitored from a computer at front-of-house or backstage, or from a laptop anywhere within the venue over WiFi.

 **NOTE:** For the latest RMS system requirements, visit [meyersound.com](http://meyersound.com).

 **NOTE:** RMS does not control AC power.

 **NOTE:** RMS-equipped loudspeakers include a Mute Jumper to enable the loudspeaker’s mute and solo capability. Meyer Sound currently ships RMS-equipped loudspeakers with the Mute Jumper installed. These mute-enabled loudspeakers can be identified by the blue “ME” sticker on the face of the RMS module. Older RMS-equipped loudspeakers can easily be mute-enabled by installing the Mute Jumper. For more information, refer to the RMsServer Hardware Guide (PN 05.222.024.01) available at [meyersound.com/documents](http://meyersound.com/documents).

 **NOTE:** The RMS software allows disabling of the Mute and Solo functions to eliminate any possibility of accidentally muting loudspeakers. Mute and solo capability can also be disabled by removing the Mute Jumper from RMS modules. For more information, refer to the RMsServer Quick Start Guide (PN 05.222.005.01) available at [meyersound.com/documents](http://meyersound.com/documents).

### COMPASS RMS SOFTWARE

Compass RMS™ software provides extensive system status and performance data for each loudspeaker, including amplifier voltage, limiting activity, power output, heat sink temperature, fan and driver status, as well as mute and solo capability. Loudspeakers are added to the RMS network and assigned a node name during a one-time discovery procedure. Once loudspeakers are identified on the RMS

network, they appear in Compass RMS as icons that can be customized to (Figure ).

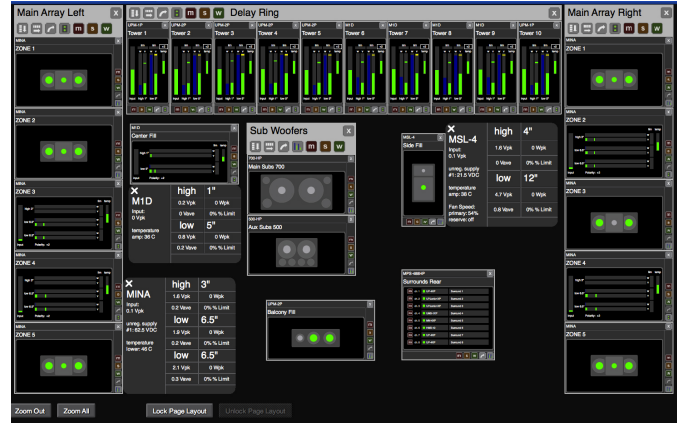

Compass RMS Window

Individual loudspeakers can be physically identified with the Wink option in RMS, which lights the Wink LED on the RMS module of that particular loudspeaker. Loudspeaker icons can be arranged in Compass RMS and saved as pages to represent how the loudspeakers have been deployed in the system. Multiple pages can be saved and recalled for specific performances and venues.

### RMS MODULE

The X-800C RMS user panel (Figure ) includes three LEDs, two buttons, and two Network connectors..

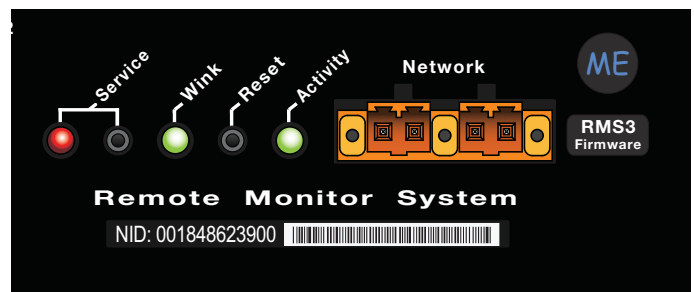

X-800C RMS Module

 **NOTE:** The LEDs and buttons on the RMS user panel are used exclusively by RMS and have no effect on the acoustical or electrical activity of the X-800C.

## Service LED (Red)

The red Service LED provides the following feedback:

- When unlit, the loudspeaker is successfully connected to the network and commissioned.
- When blinking once every two seconds, the loudspeaker is connected to the network but not yet commissioned in the RMS software.
- When lit continuously, the loudspeaker's RMS hardware has failed and may indicate that the module has been damaged (contact Meyer Sound Technical Support).

## Service Button

Pressing the Service button identifies the loudspeaker on the RMS network and notifies the RMS software that the loudspeaker is connected. Simultaneously press the Reset and Service buttons to reset the RMS module and decommission the loudspeaker from the network (see "Resetting the RMS Module").

## Wink LED (Green)

The green Wink LED lights when a signal is sent from the RMS software by clicking the Wink button on the loudspeaker's icon or on its Text view. This feature is useful for identifying the physical loudspeaker corresponding to a loudspeaker icon in the RMS software.

## Reset Button

Pressing the Reset button causes the RMS module's firmware to reboot; this action will not affect whether the loudspeaker is commissioned (which is stored in flash memory). Simultaneously press the Reset and Service buttons to reset the RMS module and decommission the loudspeaker from the network (see "Resetting the RMS Module").

## Activity LED (Green)

The green Activity LED flashes continuously when the loudspeaker has been successfully commissioned.

## Network Connectors

The two Weidmuller connectors transfer data to and from the RMS network. Two connectors are provided to allow for easy connection of multiple (daisy-chained) loudspeakers on the network. Included with each RMS-equipped

loudspeaker are RMS cable connectors and mounting blocks for constructing RMS cables. The RMS blocks allow the cables to be securely attached to the RMS module with screws.

## RESETTING THE RMS MODULE

Use the Reset and Service buttons to reset the RMS module, which will cause the module to be decommissioned from the network.

To reset the RMS module:

1. Press and hold the Service button for 10 seconds.
2. While continuing to hold down the Service button, press and hold the Reset button for 5 seconds.
3. After releasing the Reset button, continue holding down the Service button for 5 seconds. The RMS module is reset and the loudspeaker is decommissioned. The RMS module's red Service LED blinks.

## CHAPTER 5: SYSTEM DESIGN AND INTEGRATION TOOLS

This chapter introduces MAPP, Meyer Sound's patented system design tool and the Galileo GALAXY Network Platform.

### MAPP SYSTEM DESIGN TOOL

The MAPP System Design Tool is a powerful, cross-platform application for accurately predicting the coverage pattern, frequency response, phase response, impulse response, and SPL capability of individual or arrayed Meyer Sound loudspeakers.

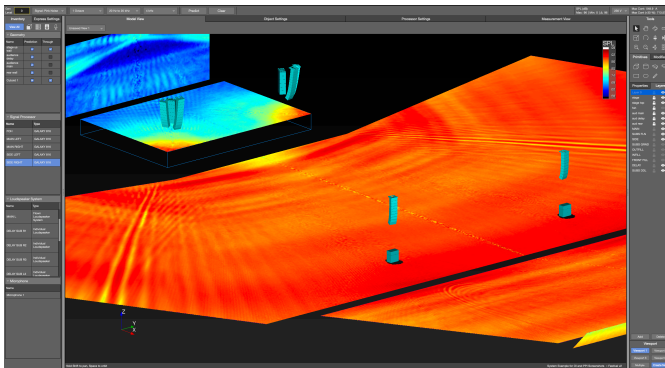

*MAPP System Design Tool*

Whether planning for fixed installations or for tours with multiple venues, use MAPP to accurately predict the appropriate loudspeaker deployment for each job, complete with coverage data, system delay and equalization settings, rigging information, and detailed design illustrations. MAPP's accurate, high-resolution predictions ensure that systems will perform as intended, thereby eliminating unexpected coverage problems and minimizing onsite adjustments.

The key to the accuracy of MAPP's predictions is Meyer Sound's exhaustive database of loudspeaker measurements. Performance predictions for each loudspeaker are based on 3-dimensional, 65,000+ 1/48th-octave-band measurements taken in the Meyer Sound anechoic chamber. The extraordinary consistency between Meyer Sound loudspeakers guarantees that predictions from MAPP will closely match their actual performance.

MAPP software allows for configuration of Meyer Sound loudspeaker systems and definition of the environment in which they operate, including air temperature, pressure, humidity, and the location of prediction surfaces. Importing both CAD (.DXF) and Sketchup (.SKP) files containing detailed venue information to act as an anchor model to the prediction surfaces and a visual aid to facilitate prediction data interpretation is also possible.



**TIP:** See [meyersound.com](http://meyersound.com) for support and more information about MAPP.

### MAPP Capabilities

With MAPP, the user can:

- Simulate different loudspeaker configurations to refine system designs and determine the best coverage for intended audience areas
- Model loudspeaker interactions to locate constructive and destructive interferences so that loudspeakers can be re-aimed and repositioned as necessary
- Place microphones anywhere in the Model View space and predict loudspeaker frequency response, phase response, and sound pressure levels at each microphone position
- Determine delay settings for fill loudspeakers using the Inverse Fast Fourier Transform and phase response feature
- Preview the results of signal processing to determine optimum settings for the best system response
- Automatically calculate load information for arrays to determine necessary minimum rigging capacity, front-to-back weight distribution, and center of gravity location
- Generate and export system images and system PDF reports for client presentations
- Synchronize GALAXY processor output channel settings in real time with virtual or real GALAXY units, allowing in-the-field changes to be predicted during system alignments.

## **GALILEO GALAXY NETWORK PLATFORM**

The Galileo GALAXY Network Platform is a sophisticated loudspeaker management tool for controlling all Meyer Sound speaker types. The GALAXY loudspeaker processor extends a high level of audio control in driving and aligning loudspeaker systems with multiple zones. It provides a powerful tool set for corrective equalization (EQ) and creative fine-tuning for a full range of applications from touring to cinema.

Users can readily program the GALAXY processor using Compass software running on a host computer or via the Compass Go application for the iPad. Connecting MAPP to the GALAXY processor will also allow the user to push output channel settings created in MAPP as a starting point. Compass Control Software includes custom-designed settings for each family of speakers, as well as to integrate families together. For example, the Product Integration feature matches the phase characteristics between Meyer speaker families to ensure the most coherent summation.

Processing tools for inputs and outputs include delay, parametric EQ and U-Shaping EQ. Output processing also includes polarity reversal, Low-Mid Beam Control (LMBC), atmospheric correction, and All Pass filters.

The built-in summing and delay matrices allow a user to easily assign gain and delay values, respectively, at each cross point. This capability greatly facilitates using one loudspeaker to satisfy multiple purposes.

Front panel controls let a user intuitively and quickly operate a GALAXY processor without a computer during live use.

The GALAXY 408, GALAXY 816 and GALAXY 816-AES3 processor versions have the same audio processing capability with different I/O. See [www.meyersound.com](http://www.meyersound.com) to locate their datasheets for more information.

## APPENDIX A: X-800C SPECIFICATIONS

### ACOUSTICAL, ELECTRICAL, PHYSICAL AND ENVIRONMENTAL SPECIFICATIONS

#### X-800C Specifications

ACOUSTICAL	
Operating Frequency Range	20 Hz – 200 Hz <b>Note:</b> Recommended maximum operating frequency range. Response depends on loading conditions and room acoustics.
Frequency Response	23 Hz – 160 Hz $\pm 4$ dB <b>Note:</b> Measured in half-space at 4 m with 1/3 octave frequency resolution.
Phase Response	32 Hz to 175 Hz $\pm 30^\circ$
Linear Peak SPL	<b>133 dB (M-noise) with crest factor &gt; 12 dB</b> , 133 dB (Pink noise), 137 dB (B-noise)  <b>Note: Linear Peak SPL</b> is measured in half-space at 4 m referred to 1 m. Loudspeaker SPL compression measured with M-noise at the onset of limiting, 2-hour duration, and 50 °C ambient temperature is < 2 dB. <b>M-noise</b> is a full bandwidth (10 Hz–22.5 kHz) test signal developed by Meyer Sound to better measure the loudspeaker's music performance. It has a constant instantaneous peak level in octave bands, a crest factor that increases with frequency, and a full bandwidth Peak to RMS ratio of 18 dB. The presence of a greater-than (>) symbol with regard to crest factor indicates it may be higher depending on EQ and boundary loading. <b>Pink noise</b> is a full bandwidth test signal with Peak to RMS ratio of 12.5 dB. <b>B-noise</b> is a Meyer Sound test signal used to ensure measurements reflect system behavior when reproducing the most common input spectrum, and to verify there is still headroom over pink noise.
Coverage	360° for a single unit; varies with number of units and configuration
TRANSDUCERS	
Low Frequency	Two 18-inch cone drivers; 8 $\Omega$ nominal impedance
AUDIO INPUT	
Type	Differential, electronically balanced
Maximum Common Mode Range	$\pm 15$ V DC, clamped to earth for voltage transient protection
Connectors	Female XLR input with male XLR loop output
Input Impedance	10 k $\Omega$ differential between pins 2 and 3
Wiring	Pin 1: Chassis/earth through 220 k $\Omega$ , 1000 pF, 15 V clamp network to provide virtual ground lift at audio frequencies Pin 2: Signal + Pin 3: Signal – Case: Earth ground and chassis
Nominal Input Sensitivity	0 dBV (1.0 V rms) continuous is typically the onset of limiting for noise and music
Input Level	Audio source must be capable of producing +20 dBV (10 V rms) into 600 $\Omega$ to produce the maximum peak SPL over the operating bandwidth of the loudspeaker
AMPLIFIER	
Type	Two-channel complementary MOSFET output stages (class AB/H)
Total Output Power	1240 W peak <b>Note:</b> Wattage rating based on the maximum unclipped burst sine-wave rms voltage the amplifier will produce into the nominal load impedance.
THD, IM TIM	<.02%
Cooling	Forced air cooling, two internal fans (one ultrahigh-speed reserve fan)

**X-800C Specifications**

<b>AC POWER</b>	
Connectors	250 V NEMA L6-20 inlet or IEC 309 male inlet
Automatic Voltage Selection	Automatic, two ranges, each with high-low voltage tap (uninterrupted)
Safety Agency Rated Operating Voltage	95–125 V AC; 208–235 V AC; 50–60 Hz
Turn-on/Turn-off Points	85–134 V AC; 165–264 V AC; 50–60 Hz
<b>Current Draw</b>	
Idle Current	0.64 A rms (115 V AC); 0.32 A rms (230 V AC); 0.85 A rms (100 V AC)
Maximum Long-Term Continuous Current	8 A rms (115 V AC); 4 A rms (230 V AC); 10 A rms (100 V AC)
Burst Current	15 A rms (115 V AC); 8 A rms (230 V AC); 18 A rms (100 V AC)
Maximum Instantaneous Peak Current	22 A peak (115 V AC); 11 A peak (230 V AC); 25 A peak (100 V AC)
Inrush Current	<7 A peak (115 V AC); <7 A peak (230 V AC); 10 A peak (100 V AC)
<b>RNS NETWORK (OPTIONAL)</b>	
	Two-conductor, twisted-pair network that reports all amplifier operating parameters to host computers
<b>PHYSICAL</b>	
Enclosure	Premium birch plywood
Finish	Medium-gloss, smooth black finish; optional textured finish
Dimensions	W: 31 in (787 mm) x H: 40 in (1016 mm) x D: 20.5 in (521 mm)
Weight	221 lb (100.24 kg)
<b>ENVIRONMENTAL</b>	
Operating Temperature	0° C to +45° C
Non Operating Temperature	–40° C to +75° C
Humidity	to 95% at 35° C
Operating Altitude	to 4600 m (15,000 ft)
Non Operating Altitude	to 12,000 m (39,000 ft)
Shock	30 g 11 msec half-sine on each of 6 sides
Vibration	10 Hz – 55 Hz (0.010 m peak-to-peak excursion)



## X-800C COMPLIANCE



## X-800C DIMENSIONS

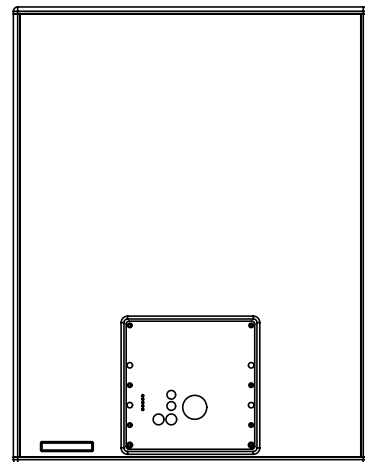
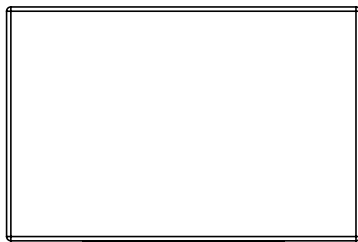
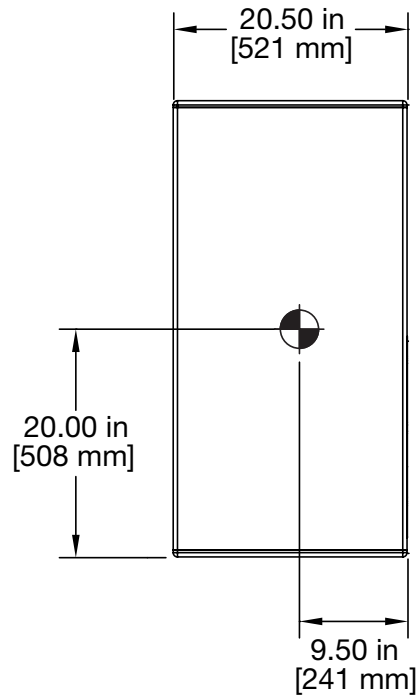
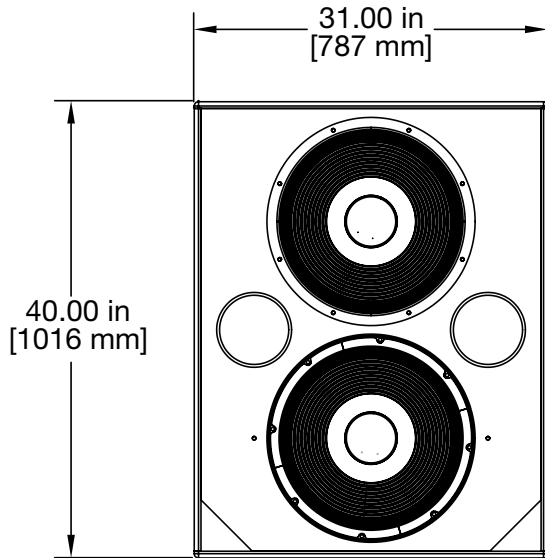







THINKING SOUND

Meyer Sound Laboratories Inc.  
2832 San Pablo Avenue  
Berkeley, CA 94702

[meyersound.com](http://meyersound.com)  
T: +1 510 486.1166

© 2012, 2021  
Meyer Sound Laboratories Inc. All rights reserved  
X-800C Operating Instructions PN 05.087.011.01 A2