

ULTRA-X20/22/23 Rigging Accessories



Meyer Sound's new ULTRA-X20/22/23 loudspeaker provides high power output, low distortion, and consistent polar response in a compact, vented enclosure. For more information, visit meyersound.com

The ULTRA-X20/22/23 loudspeaker cabinet includes two integral M8 rigging points on each end and four M6 mounting points on its heatsink. With its integrated rigging, the ULTRA-X20/22/23 is ready for a variety of applications including those requiring pole mounting, hanging individually in horizontal or vertical orientations, or two-loudspeaker arrays.

OPTIONAL RIGGING ACCESSORIES

MYA-X20 Yoke Kit (PN 40.297.450.01): The MYA-X20 Yoke suspends a single ULTRA-X20/22/23 loudspeaker and supports a wide range of horizontal and vertical adjustments. The yoke attaches to the top and bottom of the loudspeaker using two included M8 bolts/washers. The kit also includes two M8 knobs/washers. The yoke may also be mounted on a 35 mm pole to facilitate easy panning and tilting by using the optional PAS-M8 Adapter Sleeve.

MTC-X20 Top Channel Kit (PN 40.297.430.01): The MTC-X20 Top Channel kit includes a pinnable link in a channel that mounts directly to the top of the ULTRA-X20/22/23 rig nuts and supports pick-up of up to two ULTRA-X20/22/23 loudspeakers from a single point using the two included lock pins and 3/8-inch shackle. The kit includes two M8 socket head screws for attaching the channel to the loudspeaker.

PAS-M8 Adapter Sleeve M8 (35 MM Pole) (PN 40.010.975.01): The PAS-M8 Adapter Sleeve allows the user to connect a 35 mm pole to the ULTRA-X20 M8 rig nuts on the top/bottom of the loudspeaker. It can also be used with the MYA-X20 to pole-mount the yoke (a nut and washer are required for this application).

MUB-X20 U-Bracket Kit (40.297.454.01): The MUB-X20 U-Bracket allows a single ULTRA-X20/22/23 loudspeaker to be mounted to a wall (in either vertical or horizontal orientations), to the ceiling or onto the floor. The kit includes two M8 bolts/washers and two M8 knobs/washers.

MPK-POLE 35MM/M20 Adjustable Pole Kit (PN 40.010.973.01): Adjustable length 927–1524 mm (36.5–60 in) pole with assisted lift. Lower shaft fits 35 mm cups or use the removable M20 threaded lug for added stability in pole mount cups. Additional 35 mm to 38 mm (1.5 in) adapter included. Upper shaft includes PAS-M8 Adapter Sleeve to fit loudspeakers with M8 rig nuts onto a 35 mm speaker stand. The PAS-M20 and 750-LFC/900-LFC Subwoofer Internal Pole Mount Cup (35 mm/M20) are also included.

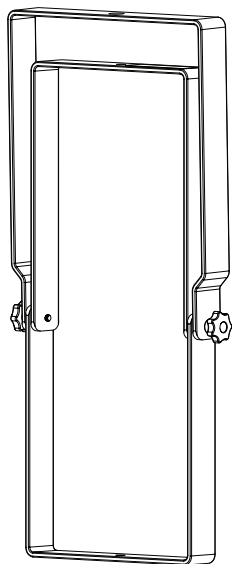

MYA-X20 Yoke
(PN 40.297.450.01)

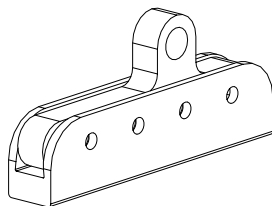

MTC-X20 Top Channel
(PN 40.297.430.01)

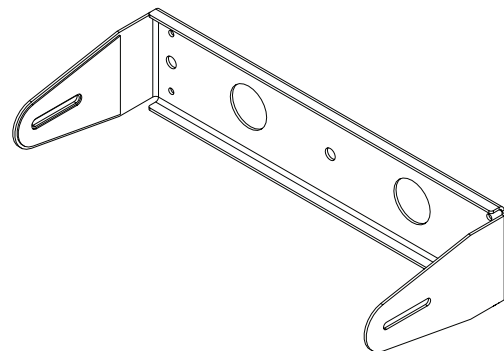

MUB-X20 U-Bracket (PN 40.297.454.01)

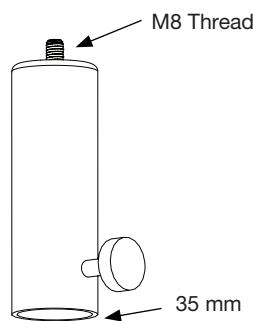

PAS-M8 Adapter Sleeve
M8 (35 MM Pole)
(PN 40.010.975.01)

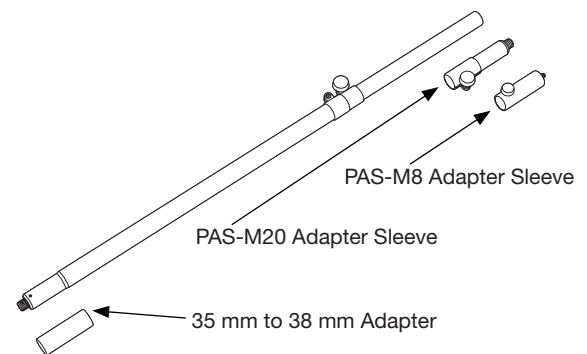

MPK-POLE Pole Kit (PN 40.010.973.01)

EXAMPLE RIGGING ACCESSORY IMPLEMENTATIONS

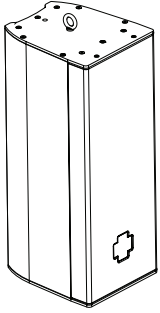

Using an Eye Bolt to hang a single ULTRA-X20

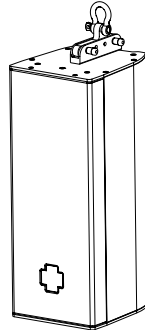

MTC-X20 Top Channel

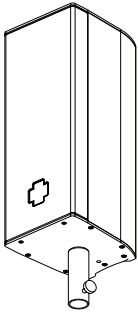

PAS-M8 Adapter Sleeve M8 (35 MM Pole) inserted in an ULTRA-X20

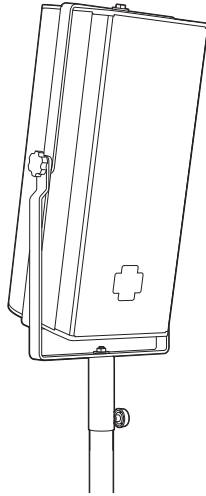

MYA-X20 Yoke Mount on Pole using optional PAS-M8 Adapter Sleeve

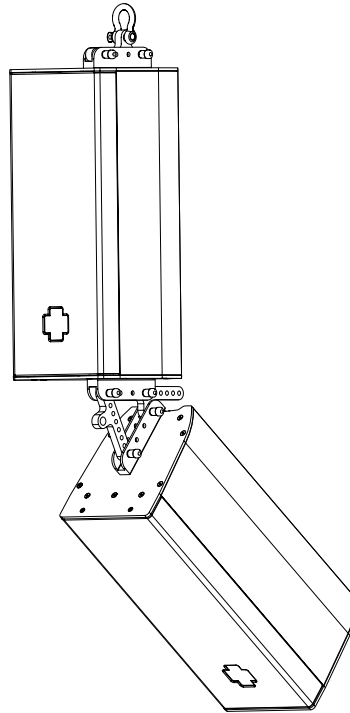

Two MTC-X20 Top Channels linking speakers (a third MTC-X20 on top).



MYA-X20 Yoke Mount

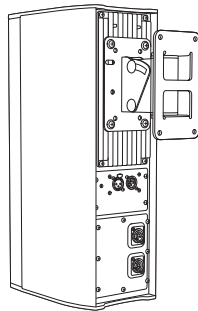

ULTRA-X20 Mounted from Heatsink with third-party bracket

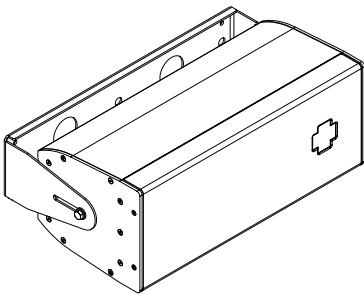

MUB-X20 Wall Mount, Horizontal

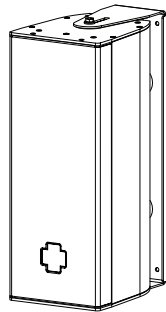

MUB-X20 Wall Mount, Vertical

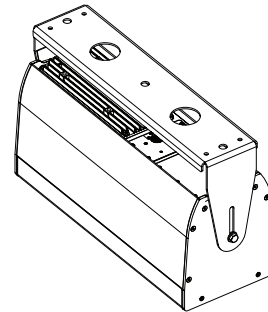

MUB-X20 Ceiling Mount