

Ultra Reflex LF-18 Screen Channel Low Frequency Loudspeaker



***Keep these important operating instructions.
Check www.meyersound.com for updates.***

© 2021

Meyer Sound Laboratories, Incorporated. All rights reserved.
Ultra Reflex LF-18 Operating Instructions, PN 05.312.005.01 A

The contents of this manual are furnished for informational purposes only, are subject to change without notice, and should not be construed as a commitment by Meyer Sound Laboratories, Incorporated. Meyer Sound assumes no responsibility or liability for any errors or inaccuracies that may appear in this manual. Except as permitted by applicable copyright law, no part of this publication may be reproduced, stored in a retrieval system, or transmitted, in any form or by any means, electronic, mechanical, recording or otherwise, without prior written permission from Meyer Sound.

The contents of this manual are furnished for informational purposes only, are subject to change without notice, and should not be construed as a commitment by Meyer Sound Laboratories, Incorporated. Meyer Sound assumes no responsibility or liability for any errors or inaccuracies that may appear in this manual. Except as permitted by applicable copyright law, no part of this publication may be reproduced, stored in a retrieval system, or transmitted, in any form or by any means, electronic, mechanical, recording or otherwise, without prior written permission from Meyer Sound.

MEYER SOUND and the Meyer Sound wave logo are trademarks of Meyer Sound Laboratories, Incorporated and are registered in the United States Patent and Trademark Office, as well as in other countries.

The following is a partial list of additional Meyer Sound trademarks and service marks:







650-P®, 650-R2®, 750-LFC, 900-LFC, 1100-LFC, Acheron®, Acheron® 80, Acheron® 100, Acheron® Designer, Acheron® LF, Acheron® Studio, AlignALink, Amie®, Amie®-Sub, B-Noise, Bluehorn® System, BroadbandQ®, CAL®, CAL® 32, CAL® 64, CAL® 96, Callisto®, Compass®, Compass® Go by Meyer Sound, Compass® RMS, Composite EQ, Constellation®, CueConsole, CueStation, D-Mitri®, EXP®, Galileo®, Galileo® GALAXY 408, Galileo® GALAXY 816, Galileo® GALAXY 816-AES3, GuideALink, HMS-5, HMS-10, HMS-12, HMS-15, Intelligent AC, IntelligentDC, JM-1P, LCS, LEO®, LEO® Family, LEO®-M, LEOPARD®, LEOPARD®-M80, Libra®, LINA®, LYON®, LYON®-M, LYON®-W, LYON®-WXT, M Series, M'elodie®, M1D, M2D, M3D, MAPP, MAPP 3D, MAPP Online Pro®, MAPP XT, Matrix3, MatrixLink, MDM-832, MDM-5000, MICA®, MILO®, MINA, MJF-208, MJF-210, MJF-212A, MM-4XP, MM-4XPD, MM-10, MM-10ACX, MM-10XP, MPS-482HP, MPS-488HP, MSL-4®, MultiSense, QuickFly®, QuietCool, REM®, RMS, RMServer, SB-2, SB-3F, SIM®, SIM® 3, Spacemap®, Spacemap® Go, SpeakerSense, Stella, Thinking Sound®, TM Array, TruPower®, TruShaping®, U-Shaping®, ULTRA-X20, ULTRA-X22, ULTRA-X23, ULTRA-X40, ULTRA-X42, UltraSeries, UMS-1P, UMS-1XP, UP-4slim, UP-4XP, UPJ-1P, UPJ-1XP, UPJunior, UPJunior-XP, UPM-1P, UPM-1XP, UPM-2P, UPM-2XP, UPQ-D1, UPQ-D2, UPQ-D3, USW-112P, USW-112XP, USW-210P, VariO, VLFC, VRAS, Wild Tracks, X-400C, X-800C.

All third-party trademarks mentioned herein are the property of their respective trademark holders.

IMPORTANT SAFETY INSTRUCTIONS

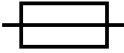
These symbols indicate important safety or operating features in this booklet and on the frame or chassis:

SYMBOLS USED

					
Dangerous voltages: risk of electric shock	Important operating instructions	Replaceable Fuse	Protective earth ground	Hot surface: do not touch	Electronic instructions for use: instruction location in QR code 
Gefährliche Spannungen: Stromschlaggefahr	Hinweis auf wichtige Punkte der Betriebsanleitung	Austauschbare Sicherung	Schutzerde	Heiße Oberfläche: nicht berühren	Elektronische Gebrauchsanweisung: anweisungsort im QR-Code
Pour indiquer les risques résultant de tensions dangereuses	Instructions d'utilisation importantes	Fusible remplaçable	Terre de protection	Surface chaude: ne pas toucher	Mode d'emploi électronique: emplacement des instructions dans le code QR
Para indicar voltajes peligrosos	Instrucciones importantes de funcionamiento y/o Mantenimiento	Fusible reemplazable	Toma de tierra de protección	Superficie caliente: no tocar	Instrucciones de uso electrónicas: ubicación de instrucciones en el código QR

1. Read these instructions.
2. Keep these instructions.
3. Heed all warnings.
4. Follow all instructions.
5. Do not use this apparatus near water.
6. Clean only with dry cloth.
7. Do not block any ventilation openings. Install in accordance with Meyer Sound's installation instructions.
8. Do not install near any heat sources such as radiators, heat registers, stoves, or other apparatus that produce heat.
9. Do not defeat the safety purpose of the grounding-type plug. A grounding type plug has two blades and a third grounding prong. The third prong is provided for your safety. If the provided plug does not fit into your outlet, consult an electrician for replacement of the obsolete outlet.
10. Protect the power cord from being walked on or pinched, particularly at plugs, convenience receptacles, and the point where they exit from the apparatus. The AC mains plug or appliance coupler shall remain readily accessible for operation.
11. Only use attachments/accessories specified by Meyer Sound.
12. Use only with the caster rails or rigging specified by Meyer Sound, or sold with the apparatus. Handles are for carrying only.
13. Unplug this apparatus during lightning storms or when unused for long periods of time.
14. If equipped with an external fuse holder, the replaceable fuse is the only user-serviceable item. When replacing the fuse, only use the same type and the same value.
15. Refer all other servicing to qualified service personnel. Servicing is required when the apparatus has been damaged in any way, such as when the power-supply cord or plug has been damaged; liquid has been spilled or objects have fallen into the apparatus; rain or moisture has entered the apparatus; the apparatus has been dropped; or when for undetermined reasons the apparatus does not operate normally.

 **WARNING:** For Meyer Sound IntelligentDC Power Supply models MPS-488HP and MPS-482HP, the external wiring connected to the output terminals of the units require installation by an Instructed person or the use of ready-made leads or cords.

 **WARNING:** To reduce the risk of fire or electric shock, do not expose this apparatus to rain or moisture. Do not install the apparatus in wet or humid locations without using weather protection equipment from Meyer Sound.

 **WARNING:** Class I apparatus shall be connected to a mains socket outlet with a protective earthing connection.

 **CAUTION:** Disconnect the mains plug before disconnecting the power cord from the loudspeaker.

English

- To reduce the risk of electric shock, disconnect the apparatus from the AC mains before installing audio cable. Reconnect the power cord only after making all signal connections.
- Connect the apparatus to a two-pole, three-wire grounding mains receptacle. The receptacle must be connected to a fuse or circuit breaker. Connection to any other type of receptacle poses a shock hazard and may violate local electrical codes.
- Do not install the apparatus in wet or humid locations without using weather protection equipment from Meyer Sound.
- Do not allow water or any foreign object to get inside the apparatus. Do not put objects containing liquid on or near the unit.
- To reduce the risk of overheating the apparatus, avoid exposing it to direct sunlight. Do not install the unit near heat-emitting appliances, such as a room heater or stove.
- If equipped with an external fuse holder, the replaceable fuse is the only item that can be serviced by the user. When replacing the fuse, only use the same type and value.
- This apparatus contains potentially hazardous voltages. Do not attempt to disassemble the unit. The only user-serviceable part is the fuse. All other repairs should be performed only by factory-trained service personnel.

Deutsch

- Zur Minimierung der Gefahr eines elektrischen Schlages trennen Sie das Produkt vor dem Anschluss von Audio- und/oder Steuerleitungen vom Stromnetz. Das Netzkabel darf erst nach Herstellung aller Signalverbindungen wieder eingesteckt werden.

- Das Produkt an eine vorschriftsgemäss installierte dreipolige Netzsteckdose (Phase, Neutralleiter, Schutzleiter) anschließen. Die Steckdose muss vorschriftsgemäß mit einer Sicherung oder einem Leitungsschutzschalter abgesichert sein. Das Anschließen des Produkts an eine anders ausgeführte Stromversorgung kann gegen Vorschriften verstossen und zu Stromunfällen führen.
- Das Produkt nicht an einem Ort aufstellen, an dem es direkter Wassereinwirkung oder übermäßig hoher Luftfeuchtigkeit ausgesetzt werden könnte, solange es sich nicht um ein Produkt handelt, dass mit der Meyer Sound Weather Protection Option ausgestattet ist.
- Vermeiden Sie das Eindringen von Wasser oder Fremdkörpern in das Innere des Produkts. Stellen Sie keine Objekte, die Flüssigkeit enthalten, auf oder neben dem Produkt ab.
- Um ein Überhitzen des Produkts zu verhindern, halten Sie das Gerät von direkter Sonneneinstrahlung fern und stellen Sie es nicht in der Nähe von wärmeabstrahlenden Geräten (z.B. Heizgerät oder Herd) auf.
- Bei Ausstattung mit einem externen Sicherungshalter ist die austauschbare Sicherung das einzige Gerät, das vom Benutzer gewartet werden kann. Verwenden Sie beim Austausch der Sicherung nur den gleichen Typ und Wert.
- Dieses Gerät enthält möglicherweise gefährliche Spannungen. Versuchen Sie nicht, das Gerät zu zerlegen. Der einzige vom Benutzer zu wartende Teil ist die Sicherung. Alle anderen Reparaturen dürfen nur von im Werk geschultem Servicepersonal ausgeführt werden.

Français

- Pour éviter tout risque d'électrocution, débranchez l'enceinte de la prise secteur avant de mettre en place le câble audio. Ne rebranchez le cordon secteur qu'après avoir procédé à toutes les connexions de signal audio
- Brancher l'appareil sur une prise secteur à trois fils et deux pôles avec mise à la terre. La prise doit être reliée à un fusible ou à un disjoncteur. Le branchement à tout autre type de prise présente un risque de choc électrique et peut enfreindre les codes locaux de l'électricité.
- N'installez pas l'enceinte dans des endroits humides ou en présence d'eau sans utiliser d'équipements de protection adéquats fournis par Meyer Sound.
- Ne laissez pas d'eau ou d'objet étranger, quel qu'il soit, pénétrer à l'intérieur de l'enceinte. Ne posez pas d'objet contenant du liquide sur ou à proximité de l'enceinte.
- Pour réduire les risques de surchauffe, évitez d'exposer directement l'enceinte aux rayons du soleil. Ne l'installez pas à proximité de sources de chaleur, radiateur ou four par exemple.

- S'il est équipé d'un porte-fusible externe, le fusible remplaçable est le seul élément qui peut être réparé par l'utilisateur. Lors du remplacement du fusible, n'utilisez que le même type et la même valeur.
- Cet appareil contient des tensions potentiellement dangereuses. N'essayez pas de démonter l'appareil. Le fusible est la seule pièce réparable par l'utilisateur. Toutes les autres réparations doivent être effectuées uniquement par du personnel de maintenance formé en usine.

Español

- Para reducir el riesgo de descarga eléctrica, desconecte el aparato de la red eléctrica antes de instalar el cable de audio. Vuelva a conectar el cable de alimentación sólo después de realizar todas las conexiones de señal.
- Conecte el aparato a una toma de corriente de tres hilos y dos polos con conexión a tierra. El receptáculo debe estar conectado a un fusible o disyuntor. La conexión a cualquier otro tipo de receptáculo representa un riesgo de descarga eléctrica y puede violar los códigos eléctricos locales.
- No instale el aparato en lugares húmedos o mojados sin usar el equipo de protección contra intemperie de Meyer Sound.
- No permita que penetre agua u otros objetos extraños en el interior del aparato. No coloque objetos que contengan líquido sobre o cerca de la unidad.
- Para reducir el riesgo de sobrecalentamiento del aparato, evite exponerlo a la luz solar directa. No instale la unidad cerca de aparatos que emitan calor, como un calefactor o una estufa.
- Si está equipado con un portafusibles externo, el fusible reemplazable es el único elemento que puede ser reparado por el usuario. Cuando reemplace el fusible, use solamente el mismo tipo y valor.
- Este aparato contiene voltajes potencialmente peligrosos. No intente desmontar la unidad. La única pieza que el usuario puede reparar es el fusible. Todas las demás reparaciones deben ser realizadas únicamente por personal de servicio capacitado de fábrica.

CONTENTS

Important Safety Instructions	iii
Symbols Used	iii
Introduction	1
How to Use This Manual	1
Ultra Reflex LF-18 Screen Channel Low Frequency Loudspeaker	1
Power Requirements	3
AC Power Distribution	3
AC Connectors	4
Wiring AC Power Cables	5
Ultra Reflex LF-18 Voltage Requirements	5
Ultra Reflex LF-18 Current Requirements	5
Intelligent AC Power Supply	6
Electrical Safety Guidelines	6
Amplification and Audio	9
Audio Connectors	9
Cable Rings	10
TruPower Limiting	10
Amplifier Cooling System	11
Active/Status LED	11
QuickFly Rigging	13
Important Safety Considerations!	13
Ultra Reflex LF-18 Rigging Options	13
Groundstacking Ultra Reflex LF-18 Loudspeakers	14
MRK-900-LFC Rigging Kit	14
Ultra Reflex LF-18 GuideALinks	14
RMS Remote Monitoring System	17
Compass RMS Software	17
RMS Module	17
Neuron ID for RMS Module	18
Resetting the RMS Module	18
Ultra Reflex LF-18 Specifications	19
Ultra Reflex LF-18 Dimensions	21
Ultra Reflex LF-18 with Rigging Dimensions	22

INTRODUCTION

HOW TO USE THIS MANUAL

Please read these instructions in their entirety before configuring a Meyer Sound loudspeaker system. In particular, pay close attention to material related to safety issues.

As you read these instructions, you will encounter the following icons for notes, tips, and cautions:



NOTE: A note identifies an important or useful piece of information relating to the topic under discussion.



TIP: A tip offers a helpful tip relevant to the topic at hand.



CAUTION: A caution gives notice that an action may have serious consequences and could cause harm to equipment or personnel, or could cause delays or other problems.

Information and specifications are subject to change. Updates and supplementary information are available at meyersound.com.

Meyer Sound Technical Support is available at:

- +1 510 486.1166
(Monday through Friday 9:00 am to 5:00 pm PST)
- +1 510 486.0657
(after hours support)
- meyersound.com/support

ULTRA REFLEX LF-18 SCREEN CHANNEL LOW FREQUENCY LOUDSPEAKER

Meyer Sound's Ultra Reflex LF-18 screen channel low frequency loudspeaker is a self-powered loudspeaker defined by its sonic linearity in reproducing low-frequency transients at high, continuous output levels with very low distortion.

The Ultra Reflex LF-18 integrates easily with other Meyer Sound loudspeaker systems, including LINA™ and UltraSeries™ loudspeakers, and works seamlessly with Meyer Sound cinema and surround sound solutions, such as the Acheron and HMS series to create flexible configurations that address immersive format requirements.

A class D amplifier affords unprecedented efficiency to the Ultra Reflex LF-18, significantly lowering distortion while reducing power consumption and operating temperature. The onboard amplifier and control circuitry are contained in a single, field-replaceable module.



Ultra Reflex LF-18 Screen Channel Low Frequency Loudspeaker

To guarantee optimum performance, systems with the Ultra Reflex LF-18 should be driven by Meyer Sound's Galileo GALAXY Network Platform which provides matrix routing, alignment, and processing for audio components. Ultra Reflex LF-18 loudspeakers also work with Meyer Sound's RMS™ remote monitoring system that enables comprehensive monitoring of system parameters from a Mac® or Windows®-based computer.

The Ultra Reflex LF-18 is available with or without Meyer Sound's QuickFly® rigging. When equipped with the optional MRK-900 rigging kit, the Ultra Reflex LF-18's captive GuideALinks™ allow it to be hung as a subwoofer array with variable splay angles from 0° to 5°.

The MG-LEOPARD/900-LFC grid can also be used for groundstacks with uptilt or downtilt.

Both versions of the Ultra Reflex LF-18 can be transported in stacks with the optional MCF-900-LFC caster frame.

POWER REQUIREMENTS

The Ultra Reflex LF-18 combines advanced loudspeaker technology with equally advanced power capabilities. Understanding power distribution, voltage and current requirements, and electrical safety guidelines is critical to the safe operation of the Ultra Reflex LF-18.

AC POWER DISTRIBUTION

All components in an audio system (self-powered loudspeakers, mixing consoles, and processors) must be properly connected to an AC power distribution system, ensuring that AC line polarity is preserved and that all grounding points are connected to a single node or common point using the same cable gauge (or larger) as the neutral and line cables.

CAUTION: Make sure the voltage received by the Ultra Reflex LF-18 remains within its 90–264 V AC operating range. In addition, the ground line must always be used for safety reasons and the line-to-ground voltage should never exceed 250 V AC (typically 120 V AC from line to ground).

CAUTION: Before applying AC power to any Meyer Sound self-powered loudspeaker, make sure that the voltage potential difference between the neutral and earth-ground lines is less than 5 V AC when using single-phase AC wiring.

NOTE: Improper grounding of connections between loudspeakers and the rest of the audio system may produce noise or hum, or cause serious damage to the input and output stages of the system's electronic components.

120 V AC, 3-Phase Wye System (Single Line)

Line-Neutral-Earth/Ground

Figure 1 illustrates a basic 120 V AC, 3-phase Wye distribution system with the loudspeaker load distributed across all three phases, with each loudspeaker connected to a single line and common neutral and earth/ground lines. This system delivers 120 V AC to each loudspeaker.

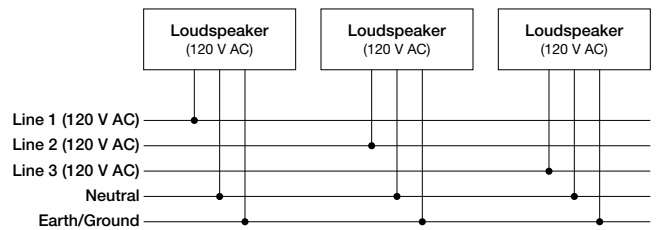

Figure 1: 120 V AC, 3-Phase Wye System (Single Line to Loudspeakers)

120 V AC, 3-Phase Wye System (Two Lines)

Line-Line-Earth/Ground

Figure 2 illustrates a 120 V AC, 3-phase Wye distribution system with each loudspeaker connected to two lines and a common earth/ground line. This configuration is possible because the Ultra Reflex LF-18 tolerates elevated voltages from the ground line and does not require a neutral line. This system delivers 208 V AC to each loudspeaker.

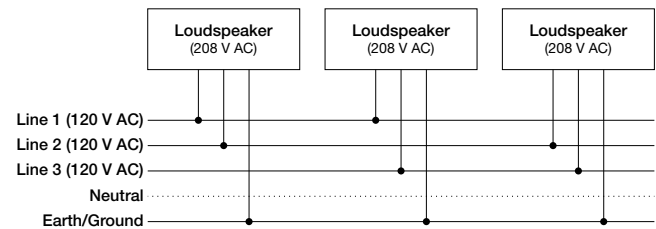

Figure 2: 120 V AC, 3-Phase Wye System (Two Lines to Loudspeakers)

TIP: The 120 V AC, 3-phase Wye system with two lines is recommended because it allows loudspeakers to draw less current than with single-line systems, thereby reducing voltage drop due to cable resistance. It also excludes the potential of varying ground to neutral voltages producing an audible hum.

230 V AC, 3-Phase Wye System (Single Line)

Line-Neutral-Earth/Ground

Figure 3 illustrates a basic 230 V AC, 3-phase Wye distribution system with the loudspeaker load distributed across all three phases, with each loudspeaker connected to a single line and common neutral and earth/ground lines. This system delivers 230 V AC to each loudspeaker.

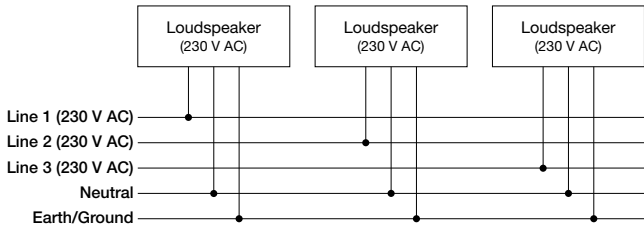

Figure 3: 230 V AC, 3-Phase Wye System (Single Line to Loudspeakers)

CAUTION: For 230 V AC, 3-phase Wye systems, never connect two lines to the AC input of the Ultra Reflex LF-18, as the resulting voltage would exceed the upper voltage limit (275 V AC) and will damage the loudspeaker.

AC CONNECTORS

The Ultra Reflex LF-18 user panel includes two powerCON 20 connectors (Figure 4), one for AC Input (blue) and one for AC Loop Output (gray).



Figure 4: AC Input (Left) and AC Loop Output (Right) Connectors

AC Input (Blue)

The blue AC Input connector supplies power to the Ultra Reflex LF-18. The 3-conductor powerCON 20 is rated at 20 A and uses a locking connector that prevents accidental disconnections. A 10-foot AC power cable, rated at 15 A, is included with each loudspeaker. If you replace the included AC power cable, make sure to use a cable with the appropriate power plug (on the other end) for the area in which you will operate the loudspeaker. The Ultra Reflex LF-18 requires a grounded outlet. To operate safely and effectively, it is extremely important that the entire system be properly grounded.

The AC Input connector also supplies power to any additional loudspeakers connected to the loudspeaker’s gray Loop Output connector.

CAUTION: When looping AC power for loudspeakers, do not exceed the current capability of the AC Input connector (20 A) or

the included AC power cable (15 A). Consider the total current draw for all loudspeakers on the circuit, including the first loudspeaker (Table 1).

AC Loop Output (Gray)

The gray AC Loop Output connector allows multiple Ultra Reflex LF-18 to be looped and powered from a single power source. The 3-conductor powerCON 20 is rated at 20 A and uses a locking connector that prevents accidental disconnections. For applications that require multiple Ultra Reflex LF-18, connect the AC Loop Output of the first loudspeaker to the AC Input of the second loudspeaker, and so forth.

The maximum number of loudspeakers that can be looped from the AC Loop Output connector is determined by the voltage of the power source, the current draw of the looped loudspeakers, the circuit breaker rating, and the rating of the AC power cable connected to the first Ultra Reflex LF-18 loudspeaker (Table 1).

Table 1: Maximum Ultra Reflex LF-18 that Can Be Looped with AC Power

Circuit Breaker/ Connector Rating	115 V AC	230 V AC	100 V AC
15 A / 16 A	2 looped (3 total)	5 looped (6 total)	1 looped (2 total)
20 A	3 looped (4 total)	7 looped (8 total)	2 looped (3 total)

NOTE: Current draw for the Ultra Reflex LF-18 is dynamic and fluctuates as operating levels change. The indicated number of loudspeakers that can be looped assumes that operating levels are normal and not such that loudspeakers are constantly limiting.

The Ultra Reflex LF-18 ships with a gray powerCON 20 cable mount connector, rated at 20 A, for assembling AC looping cables. Assembled AC looping cables are also available from Meyer Sound.

CAUTION: When looping AC power for loudspeakers, do not exceed the current capability of the AC Input connector (20 A) or the included AC power cable (15 A). Consider the total current draw for all loudspeakers on the circuit, including the first loudspeaker (Table 1).

WIRING AC POWER CABLES

The Ultra Reflex LF-18 ships with a gray powerCON 20 cable mount connector (Figure 5), rated at 20 A, for assembling AC looping cables. The pins on the powerCON 20 cable mount connector are labeled as follows:

- L (Line)
- N (Neutral)
- PE (Protective Earth or Ground)

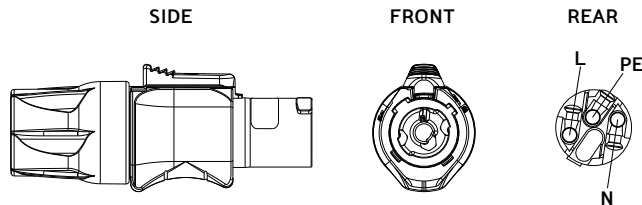

Figure 5: powerCON 20 Cable Mount Connector

How AC power cables are wired is determined by the type of AC power distribution system used (“AC Power Distribution” on page 3). When wiring AC power cables for single-line systems, use one of the wiring schemes described in Table 2 and illustrated in Figure 6:

Table 2: AC Wiring Scheme

Wire Color		Attach to the Following Terminal
U.S. / Canada 60 Hz	European 50 Hz	
Black	Brown	Hot or live (L)
White	Blue	Neutral (N)
Green	Green and Yellow	Protective earth / ground (E or PE)

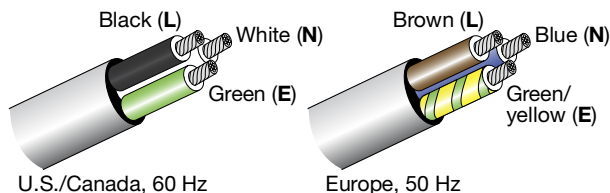

Figure 6: AC Wiring Scheme, illustrated

CAUTION: When wiring AC power cables and distribution systems, it is important to preserve AC line polarity and connect the earth ground on both ends of the cable. The Ultra Reflex LF-18 requires a grounded connection. Always use a grounded outlet and plug. It is extremely important that the system be properly grounded to operate safely and properly. Do not ground-lift the AC cable.

ULTRA REFLEX LF-18 VOLTAGE REQUIREMENTS

The Ultra Reflex LF-18 operates as intended when receiving AC voltage within the following range:

- 90–264 V AC, 50–60 Hz

If the voltage drops below 90 V, the loudspeaker uses stored power to continue operating temporarily; the loudspeaker powers off if the voltage does not return to its operating range.

If the voltage rises above 275 V, the power supply could become damaged.

CAUTION: The power source for the Ultra Reflex LF-18 should always operate within the required operating range, at least a few volts from the upper and lower limits. This ensures that AC voltage variations from the service entry—or peak voltage drops due to cable runs—will not cause the loudspeaker’s amplifier to cycle on and off or cause damage to the power supply.

ULTRA REFLEX LF-18 CURRENT REQUIREMENTS

Current draw for loudspeakers is dynamic and fluctuates as operating levels change. Because different cables and circuit breakers heat up at varying rates, it is important to understand the following types of current ratings and how they affect circuit breaker and cable specifications.

- **Idle Current** — The maximum rms current during idle periods.
- **Maximum Long-Term Continuous Current** — The maximum rms current during a period of at least 10 seconds. The maximum long-term continuous current is used to calculate temperature increases for cables to ensure that the size and gauge of the cables conform to electrical code standards. The current rating is also used to select appropriately rated, slow-reacting thermal breakers, which are recommended for loudspeaker power distribution. In addition, the maximum long-term continuous current can be used to calculate the AC looping capability for Ultra Reflex LF-18 loudspeakers.
- **Burst Current** — The maximum rms current during a period of around 1 second. The burst current is used as a rating for magnetic breakers. It is also used for calculating the peak voltage drop in long AC cable runs according to the following formula:

$$V_{pk}(\text{drop}) = I_{pk} \times R(\text{cable total})$$

- **Maximum Instantaneous Peak Current** — A rating for fast-reacting magnetic breakers.

Use the information provided in Table 3 as a guide for selecting the gauge of cables and the circuit breaker ratings for the system’s operating voltage.

Table 3: Ultra Reflex LF-18 Current Draw

Current Draw	115 V AC	230 V AC	100 V AC
Idle	0.60 A rms	0.49 A rms	0.63 A rms
Maximum Long-Term Continuous	4.9 A rms	2.5 A rms	5.2 A rms
Burst	8.8 A rms	4.7 A rms	11.0 A rms
Maximum Instantaneous Peak	18.2 A peak	9.2 A peak	20.6 A peak

The minimum electrical service amperage required by a loudspeaker system is the sum of the maximum long-term continuous current for all loudspeakers. An additional 30 percent above the combined Maximum Long-Term Continuous amperages is recommended to prevent peak voltage drops at the service entry.

 **NOTE:** For best performance, the AC cable voltage drop should not exceed 10 V (10 percent at 115 V and 5 percent at 230 V).

This ensures that the AC voltage variations from the service entry—or peak voltage drops due to longer cable runs—do not cause the amplifier to cycle on and off.

INTELLIGENT AC POWER SUPPLY

The Ultra Reflex LF-18’s Intelligent AC™ power supply automatically selects the correct operating voltage (allowing the loudspeaker to be used internationally without manually setting voltage switches), eliminates high inrush currents with soft-start power up, suppresses high-voltage transients up to several kilovolts, filters common mode and differential mode radio frequencies (EMI), and sustains operation temporarily during low-voltage periods.

Powering on the Ultra Reflex LF-18

When powering on the Ultra Reflex LF-18, the following startup events take place over several seconds.

1. Audio output is muted.
2. Voltage is detected and the power supply mode is automatically adjusted as necessary.
3. The power supply ramps up.

4. On the user panel, the Active/Status LED flashes multiple colors successively.
5. The Active/Status LED turns solid green, indicating the loudspeaker is unmuted and ready to output audio.

 **CAUTION:** If the Active/Status LED does not turn solid green, or the Ultra Reflex LF-18 does not output audio after 10 seconds, remove AC power immediately and verify that the voltage is within the required range. If the problem persists, contact Meyer Sound Technical Support.

ELECTRICAL SAFETY GUIDELINES

Make sure to observe the following important electrical and safety guidelines.

- The powerCON 20 connector should not be engaged or disengaged when under load or energized. Either de-energize or disconnect the other end of the cable.
- The Ultra Reflex LF-18 requires a grounded outlet. Always use a grounded outlet and plug.

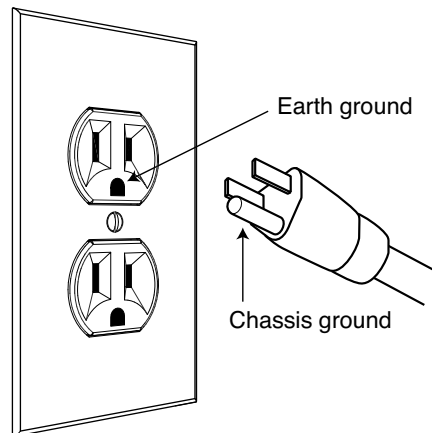

- Do not use a ground-lifting adapter or cut the AC cable ground pin.

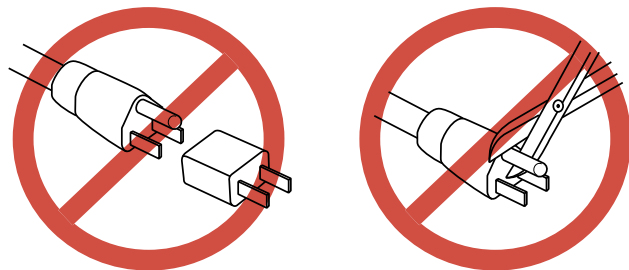

- Do not exceed the current capability of the 20 A AC Input connector for the loudspeaker. When looping loud-

speakers, consider the total current draw for all loudspeakers on the circuit, including the first loudspeaker.

- Make sure the AC power cable for the loudspeaker has the appropriate power plug (on the other end) for the area in which you will operate the loudspeaker. In addition, the AC power cable must be rated for the total current draw of all loudspeakers looped from the power source.
- Do not operate the loudspeaker if the power cable is frayed or broken.
- Keep all liquids away from Ultra Reflex LF-18 loudspeakers to avoid hazards from electrical shock.
- Use the cable rings (see “Cable Rings” on page 10) on the rear of the Ultra Reflex LF-18 cabinet to reduce strain on the AC power cable (and audio cables). Do not use the cable rings for any other purpose.

AMPLIFICATION AND AUDIO

The Ultra Reflex LF-18's drivers are powered by a proprietary two-channel, open-loop, class D amplifier. The audio signal is processed with correction filters for flat phase and frequency responses and by driver protection circuitry. Each channel has peak and rms limiters that prevent driver over-excursion and regulate voice coil temperatures.

The Ultra Reflex LF-18 user panel (Figure 7) includes Input and Loop output connectors for audio, Limit and Active LEDs, and RMS connectors and controls (see Chapter 5, "RMS Remote Monitoring System").



Figure 7: Ultra Reflex LF-18 User Panel

AUDIO CONNECTORS

The Ultra Reflex LF-18 has XLR 3-pin connectors for audio Input and audio Loop output (Figure 8).



Figure 8: XLR 3-Pin Audio Connectors, Input and Loop Output

Audio Input

The XLR 3-pin female Input connector accepts balanced audio signals with an input impedance of 10 kOhm. The connector uses the following wiring scheme:

- **Pin 1** — 1 kOhm to chassis and earth ground (ESD clamped)
- **Pin 2** — Signal (+)
- **Pin 3** — Signal (-)
- **Case** — Earth (AC) ground and chassis

Pins 2 and 3 carry the input as a differential signal. Pin 1 is connected to earth through a 1 kOhm, 1000 pF, 15 V clamped network. This circuitry provides virtual ground lift for audio frequencies while allowing unwanted signals to bleed to ground. Make sure to use balanced XLR audio cables with pins 1–3 connected on both ends. Telescopic grounding is not recommended and shorting an input connector pin to the case may cause a ground loop, resulting in hum.



TIP: If unwanted noise or hiss is produced by the loudspeaker, disconnect its input cable. If the noise stops, there is most likely nothing wrong with the loudspeaker. To locate the source of the noise, check the audio cable, source audio, AC power, and electrical ground.

Audio Loop Output

The XLR 3-pin male Loop output connector allows multiple loudspeakers to be looped from a single audio source. The Loop output connector uses the same wiring scheme as the Input output connector. For applications that require multiple Ultra Reflex LF-18, connect the Loop output of the first loudspeaker to the Input of the second loudspeaker, and so forth.



NOTE: The Loop output connector is wired in parallel to the Input connector and transmits the unbuffered source signal even when the loudspeaker is powered off.

Calculating Load Impedance for Looped Audio Signals

To avoid distortion when looping multiple loudspeakers, make sure the source device can drive the total load impedance of the looped loudspeakers. In addition, the source device must be capable of delivering approximately

20 dBV (10 V rms into 600 ohms) to yield the maximum SPL over the operating bandwidth of the loudspeakers.

To calculate the load impedance for the looped loudspeakers, divide 10 kOhms (the input impedance for a single loudspeaker) by the number of looped loudspeakers. For example, the load impedance for ten Ultra Reflex LF-18 loudspeakers is 1000 ohms (10 kOhms / 10). To drive this number of looped loudspeakers, the source device should have an output impedance of 100 ohms or less. This same rule applies when looping Ultra Reflex LF-18 loudspeakers with other Meyer Sound self-powered loudspeakers.

 **NOTE:** Most source devices are capable of driving loads no less than 10 times their output impedance.

 **TIP:** Audio outputs from Meyer Sound's Galileo GALAXY Network Platform have an output impedance of 50 ohms. Each output can drive up to 20 Meyer Sound (10 kOhm) loudspeakers without distortion.

 **CAUTION:** Make sure that all cabling for looped loudspeakers is wired correctly (Pin 1 to Pin 1, Pin 2 to Pin 2, and so forth) to prevent the polarity from being reversed. If one or more loudspeakers in a system have reversed polarity, frequency response and coverage will be significantly degraded.

CABLE RINGS

Two cable rings are provided on the rear of the Ultra Reflex LF-18 cabinet (Figure 9). Power and audio cables should be tied off to the rings to reduce strain on the cables and prevent damage to them during installation. The cable rings should not be used for any other purpose.

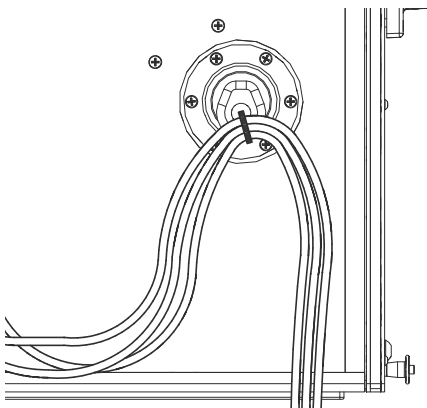



Figure 9: Cables Tied Off to Cable Ring

 **CAUTION:** Ultra Reflex LF-18 cable rings should only be used to reduce strain on cables. The cable rings should not be used for any other purpose.

TRUPOWER LIMITING

The Ultra Reflex LF-18 employs Meyer Sound's advanced TruPower® limiting. Conventional limiters assume a constant loudspeaker impedance and set the limiting threshold by measuring voltage alone. This method is inaccurate because loudspeaker impedances change as frequency content in the source material changes, and as thermal values for the loudspeaker's voice coil and magnet vary. Consequently, conventional limiters often begin limiting prematurely, which reduces system headroom and dynamic range.

In contrast, TruPower limiting anticipates varying loudspeaker impedances by measuring both current and voltage to compute the actual power dissipation in the voice coil. This approach improves performance, both before and during limiting, by allowing the driver to produce the maximum SPL across its entire frequency range, while also retaining signal peaks. TruPower limiting also eliminates power compression at high levels over lengthy periods, which helps regulate voice coil temperatures, thereby extending the life of the driver.

LF Limit LED

The low-frequency driver for the Ultra Reflex LF-18 is powered by separate amplifier channels, one for each voice coil, that are routed to a single limiter. When a safe power level is exceeded in either channel, limiting is engaged for both channels and the LF Limit LED lights (Figure 10) on the user panel (the HF Limit LED is disabled for the Ultra Reflex LF-18).

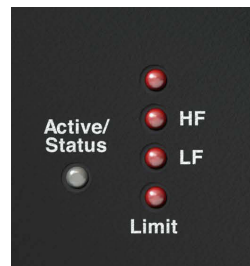



Figure 10: Ultra Reflex LF-18 Limit LEDs (HF LED Disabled)

When engaged, the limiter not only protects the drivers but also prevents signal peaks from causing excessive distortion in the amplifier channels, thereby preserving headroom and maintaining smooth frequency response at high levels. When

levels return to normal, below the limiter threshold, limiting ceases.

The Ultra Reflex LF-18 performs within its acoustical specifications at normal temperatures when the LF Limit LED is unlit, or when the LED is lit for 2 seconds or less and then turns off for at least 1 second. If the LED remains lit for longer than 3 seconds, the loudspeaker enters hard limiting where:

- Increases to the input level have no effect
- Distortion increases due to clipping
- Drivers are subjected to excessive heat and excursion, thereby compromising their lifespan

 **CAUTION:** The Limit LED indicates when a safe, optimum level is exceeded. If a Ultra Reflex LF-18 loudspeaker system begins to limit before reaching the desired SPL, consider adding more loudspeakers to the system.

AMPLIFIER COOLING SYSTEM

The Ultra Reflex LF-18 is convection cooled. The amplifier's heat sink provides natural convection cooling from the air flowing near its fins. When exposed to high ambient temperatures or when driven continuously at high output levels, a variable-speed fan circulates air internally to ensure that the Ultra Reflex LF-18 remains operational.

 **CAUTION:** To keep the Ultra Reflex LF-18 from overheating, allow at least 6 inches behind the cabinet for proper ventilation.

 **CAUTION:** The Ultra Reflex LF-18 heat sink can reach temperatures up to 80 °C (176 °F) during extreme operation. Wait 15 minutes for the loudspeaker to cool before touching.

ACTIVE/STATUS LED

During normal operation, when the Ultra Reflex LF-18 is powered on, the Active/Status LED is solid green. If the loudspeaker encounters a hardware fault, or the loudspeaker begins to overheat, the LED flashes red. In some instances, the loudspeaker will continue to output audio while the LED flashes red, though with a reduction in the limiter threshold and acoustic output to protect the loudspeaker.

If a loudspeaker is overheating (for RMS-equipped loudspeakers, this situation may be verified in Compass RMS), a reduction in SPL may be necessary. If, after a reduction in SPL and an appropriate cooling period,

the Active/Status LED continues to flash red (does not return to solid green), contact Meyer Sound Technical Support.

If the Active/Status LED flashes red and the loudspeaker does not output audio, contact Meyer Sound Technical Support immediately.

 **CAUTION:** If an Ultra Reflex LF-18 loudspeaker system consistently overheats before reaching the desired SPL, consider adding more loudspeakers to the system.

 **NOTE:** During startup, the Active/Status LED flashes multiple colors successively. For more information about the power on sequence, see “Intelligent AC Power Supply” on page 6.

 **TIP:** When the Ultra Reflex LF-18 is connected to an RMS network, the Compass RMS software provides additional feedback on the loudspeaker's hardware status and operating temperature. For more information, see Chapter 5, “RMS Remote Monitoring System.”

QUICKFLY RIGGING

IMPORTANT SAFETY CONSIDERATIONS!

When installing Meyer Sound loudspeakers and subwoofers, the following precautions should always be observed:

- All Meyer Sound products must be used in accordance with local, state, federal, and industry regulations. It is the owner's and user's responsibility to evaluate the reliability of any rigging method for their application. Rigging should only be carried out by experienced professionals.
- Use mounting and rigging hardware that has been rated to meet or exceed the weight being hung.
- Make sure to attach mounting hardware to the building's structural components (roof truss), and not just to the wall surface.
- Make sure bolts and eye bolts are tightened securely. Meyer Sound recommends using Loctite® on all threaded fasteners.
- Inspect mounting and rigging hardware regularly. Immediately replace any worn or damaged components.

ULTRA REFLEX LF-18 RIGGING OPTIONS

Table 4 summarizes the available rigging options for the Ultra Reflex LF-18.



NOTE: For complete information about rigging hardware, including dimensions, weight, configuration, and load ratings, refer to the MG-LEOPARD/900-LFC Assembly Guide (PN 05.243.080.01) available at meyersound.com/documents.

Table 4: Ultra Reflex LF-18 Rigging Options

Model	Weight	Features	Required Quick-Release Pins	Required Shackles
MRK-900-LFC rigging kit (PN 40.246.168.01)	23 lb (10.43 kg)	Allows the Ultra Reflex LF-18 to be hung and groundstacked with the MG-LEOPARD/900-LFC grid; includes six captive GuideALinks and eight quick-release pins.	5/16 x 0.63-inch (black button), PN 134.024, qty 8 included	—
MG-LEOPARD/900-LFC multipurpose grid (PN 40.243.080.01)	60.5 lb (27.5 kg)	With some restrictions, up to 16 Ultra Reflex LF-18 can be hung from this grid at a 5:1 safety factor; accommodates a variety of pickup configurations with four corner and 13 center pickup points; can also be used for groundstacking.	5/16 x 0.875-inch (red button), PN 134.025, qty 10 included	5/8-inch or 3/4-inch
MG-LEOPARD/900-LFC grid tilt kit (PN 40.243.163.01)	2 lb (0.9 kg)	Includes two angle feet that attach to the rear of the MG-LEOPARD/900-LFC grid that add from 3°–8°s of tilt to groundstacks.	5/16 x 0.875-inch (red button), PN 134.025, qty 0 included; see note below.	—
MCF-900-LFC caster frame (PN 40.246.130.01)	46 lb (20.9 kg)	Safely transports up to two Ultra Reflex LF-18 cabinets, making it easy to assemble and disassemble arrays in blocks of two cabinets; configurable for cabinets with or without the MRK-900-LFC rigging kit	5/16 x 0.63-inch (black button), PN 134.024, qty 0 included; see note below.	—



NOTE: The MCF-900-LFC caster frame does not include quick-release pins because it is secured with the quick-release pins included with the loudspeaker.



NOTE: The MG-LEOPARD/900-LFC grid tilt kit does not include quick-release pins because the angle feet are secured with the quick-release pins included with the grid.

GROUNDSTACKING ULTRA REFLEX LF-18 LOUDSPEAKERS

Ultra Reflex LF-18 can be groundstacked up to three cabinets high, with or without the MRK-900-LFC rigging kit (Figure 11). Protective plastic skids are included on the bottom of the Ultra Reflex LF-18 cabinet that align with the slots on the cabinet top. When groundstacking Ultra Reflex LF-18, make sure the skids for each cabinet align with the slots in the cabinet tops.

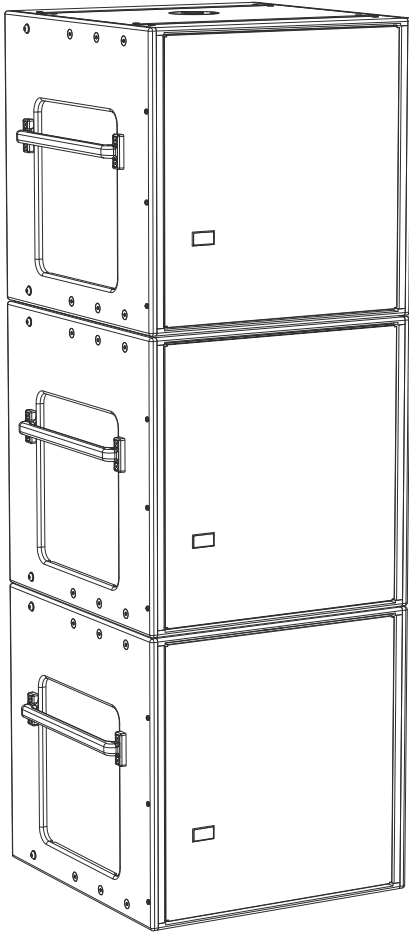

Figure 11: Ultra Reflex LF-18 Groundstack (Without Rigging)



CAUTION: As a safety precaution, to avoid tipping, a maximum of three cabinets is supported for groundstacked Ultra Reflex LF-18.



NOTE: Ultra Reflex LF-18 need not be equipped with the MRK-900-LFC rigging kit for secure groundstacking of up to three cabinets.

MRK-900-LFC RIGGING KIT

The optional MRK-900-LFC rigging kit allows the Ultra Reflex LF-18 to be flown and groundstacked with the MG-LEOPARD/900-LFC multipurpose grid. The rigging kit is available as a factory-installed option or as a field upgrade and uses rugged GuideALinks and intuitive quick-release pins to securely link adjacent loudspeakers in flown and groundstacked array configurations.



NOTE: For more information about the MRK-900-LFC rigging kit, including its kit contents, weight, and installation instructions, refer to the MG-LEOPARD/900-LFC Assembly Guide (PN 05.243.080.01) available at meyersound.com/documents.

ULTRA REFLEX LF-18 GUIDEALINKS

When equipped with the MRK-900-LFC rigging kit, the Ultra Reflex LF-18 includes six captive GuideALinks and six mating link slots that link to adjacent loudspeakers in flown and groundstacked arrays. Located at the top of the cabinet, GuideALinks extend up and into the link slots of the cabinet above it (Figure 12 and Figure 13), or into the link slots of the MG-LEOPARD/900-LFC grid, making it easy to link cabinets when they are stacked. GuideALinks extend and retract with knobs and are secured with two quick-release pins: one each in the top and bottom cabinets. GuideALinks accommodate reversed loudspeakers for cardioid arrays. The MRK-900-LFC rigging kit includes eight 5/16 x 0.63-inch quick-release pins (black button) (PN 134.024).

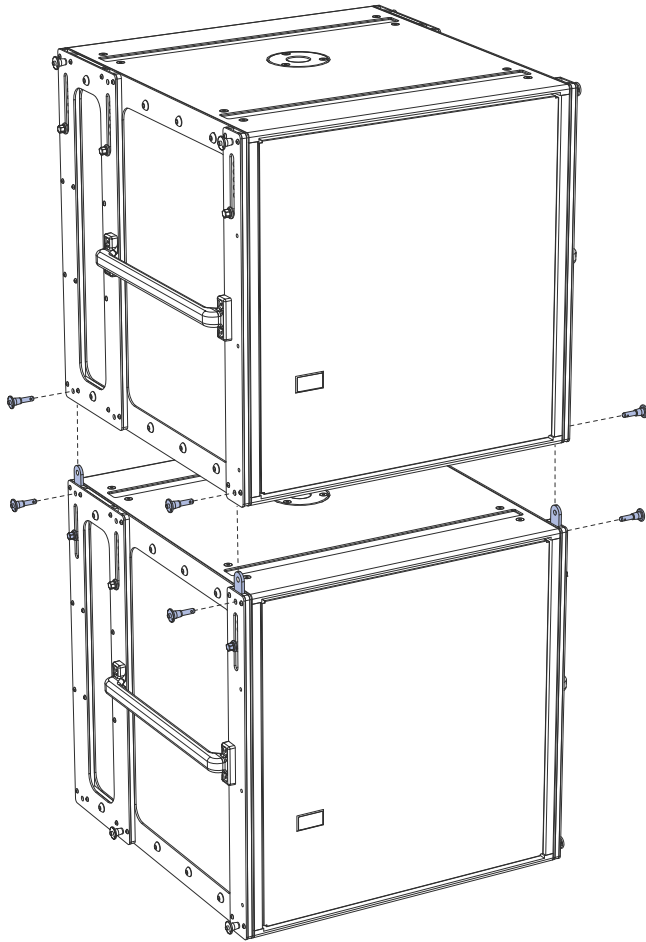

Figure 12: Ultra Reflex LF-18 with MRK-900-LFC Rigging Kit, GuideALinks, Exploded View

The front and rear GuideALinks are used when flying the Ultra Reflex LF-18 below the MG-LEOPARD/900-LFC grid, or when flying it below another Ultra Reflex LF-18 (Figure 13). The configuration of the Ultra Reflex LF-18's GuideALinks, front and rear, determines its splay angle.

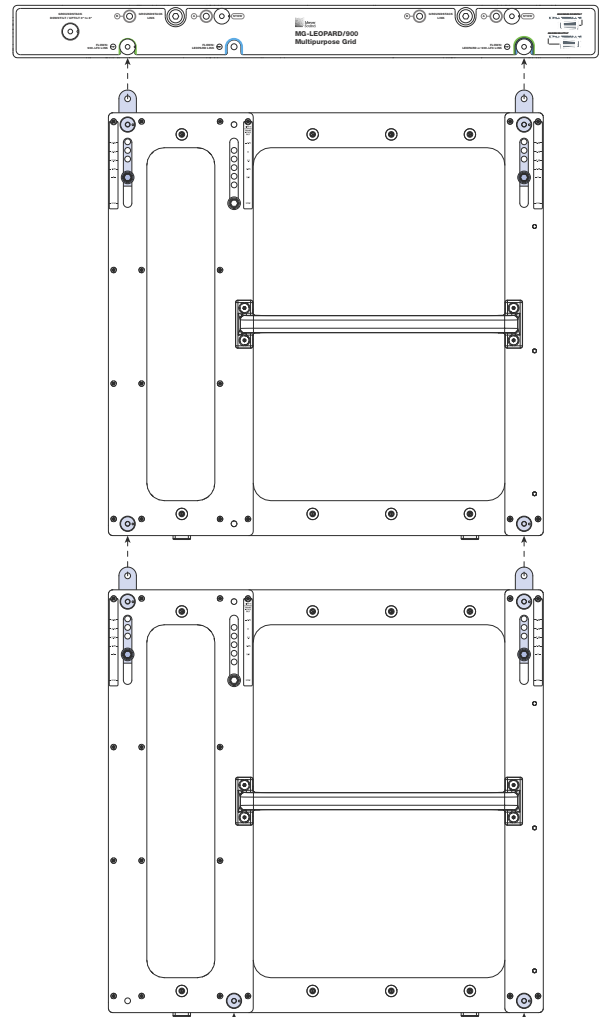

Figure 13: Flown Ultra Reflex LF-18 with GuideALink Attachments

The Ultra Reflex LF-18's four corner link slots on the bottom of the cabinet accept GuideALinks from flown Ultra Reflex LF-18s.

The Ultra Reflex LF-18's front and middle link slots also accept links from the MG-LEOPARD/900-LFC grid when groundstacking the Ultra Reflex LF-18 (Figure 14). The configuration of the grid's links, whether set to A or B, determines the angle of attachment for the groundstacked Ultra Reflex LF-18.

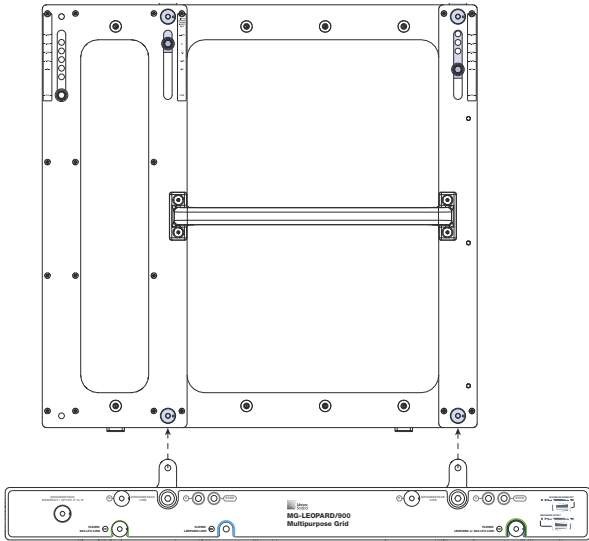

Figure 14: Groundstacked Ultra Reflex LF-18 with GuideALink Attachments

CAUTION: Do not use the middle GuideALinks when flying the Ultra Reflex LF-18 below the MG-LEOPARD/900-LFC grid or when flying below another Ultra Reflex LF-18. Always use the front and rear GuideALinks when flying the Ultra Reflex LF-18.

NOTE: To add tilt to the top cabinet, the actual grid should instead be tilted. For more information, refer to the MG-LEOPARD/900 Assembly Guide (PN 05.243.080.01) available at meyersound.com/documents.

splay angles increase. To stow the GuideALinks, move them all the way down to STOW and pin them.

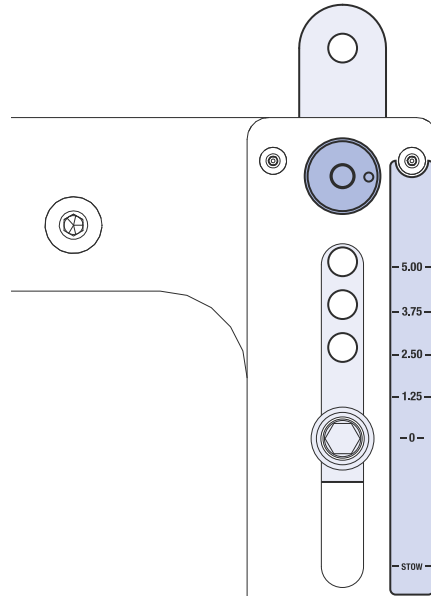

Figure 15: Ultra Reflex LF-18 Front GuideALinks Label

NOTE: Curved Ultra Reflex LF-18 arrays do not provide directionality for low-frequency content. The curved array capability of the Ultra Reflex LF-18 is provided for aesthetic reasons.

Ultra Reflex LF-18 Splay Angles

The front and rear GuideALinks attach at angles of 0.00°, 1.25°, 2.50°, 3.75°, or 5.00°, thereby allowing curved arrays for the Ultra Reflex LF-18.

The labels next to the front (Figure 15) and rear GuideALinks indicate the splay angle between cabinets (when the opposing links are set to 0°). As the links are moved up, the

RMS REMOTE MONITORING SYSTEM

The Ultra Reflex LF-18 includes an RMS remote monitoring system module, allowing the loudspeaker to be connected to an RMS network. RMS reports, in real time, the status and power usage of multiple Meyer Sound loudspeakers from a Mac or Windows-based computer. The RMS host computer communicates with Meyer Sound loudspeakers (equipped with RMS modules) via RMsServer™, a compact, Ethernet-based hardware unit with two FT-10 RMS data ports. RMsServer stores system configurations internally, eliminating most manual data entry. Systems can be monitored from a computer at front-of-house or backstage, or from a laptop anywhere within the venue over WiFi.

 **NOTE:** For the latest RMS system requirements, visit the Meyer Sound website (meyersound.com/products).

 **NOTE:** RMS does not control AC power.

COMPASS RMS SOFTWARE

Compass RMS™ software provides extensive system status and performance data for each loudspeaker, including amplifier voltage, limiting activity, power output, fan and driver status, as well as mute and solo capability. Loudspeakers are added to the RMS network and assigned a node name during a one-time discovery procedure. After loudspeakers are identified on the RMS network, they appear in Compass RMS as icons that can be customized to suit your needs (Figure 16).



Figure 16: Compass RMS Window

Individual loudspeakers can be physically identified with the Wink option in RMS, which lights the Wink LED on the RMS module of that particular loudspeaker. Conversely, a

loudspeaker can be identified in Compass RMS by pressing the Identify button on the loudspeaker's RMS module.

Loudspeaker icons can be arranged in Compass RMS and saved as pages to represent how the loudspeakers have been deployed in the system. Multiple pages can be saved and recalled for specific performances and venues.

RMS MODULE

The Ultra Reflex LF-18 RMS user panel includes an Identify button, Remote Mute switch, Wink/Activity LED, and two Network connectors (Figure 17).

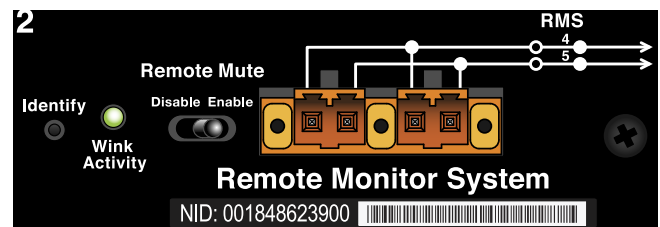



Figure 17: Ultra Reflex LF-18 RMS Module

 **NOTE:** The Identify button and Wink/Activity LED on the RMS user panel are used exclusively by RMS and have no effect on the acoustical or electrical activity of the loudspeaker.

Identify Button

The Identify button serves the following functions:

- If the loudspeaker has not yet been discovered on the RMS network (Wink/Activity LED not lit), press the Identify button to discover it.
- To remove the loudspeaker from the RMS network, press and hold the Identify button during startup (see “Resetting the RMS Module” on page 18).
- To *wink* a discovered loudspeaker, press the Identify button. The Wink LED on the loudspeaker icon in Compass RMS lights up and the Wink/Activity LED on the loudspeaker's RMS user panel turns solid green. Press the Identify button again to unwink the loudspeaker.

 **TIP:** The Wink function is useful for identifying the physical loudspeaker corresponding to a loudspeaker icon in Compass RMS.

Wink/Activity LED (Green)

The green Wink/Activity LED indicates the status of the loudspeaker:

- During startup, the LED flashes green 10 times.
- If the loudspeaker has not yet been discovered on the RMS network, the LED is not lit after startup.
- If the loudspeaker has been successfully discovered on the RMS network, the LED flashes green continuously and flashes more rapidly with increased data activity.
- When the loudspeaker is winked, either by clicking the Wink button in Compass RMS or by pressing the Identify button on the RMS user panel, the LED is solid green. The LED remains solid green until the loudspeaker is unwinked.



TIP: The loudspeaker can also be winked by clicking the Wink button on the loudspeaker icon in Compass RMS.

Remote Mute Switch

The recessed Remote Mute switch (Figure 18) on the Ultra Reflex LF-18 RMS module determines whether Compass RMS can control muting and soloing of the loudspeaker. The Ultra Reflex LF-18 ships from the factory with the switch enabled.

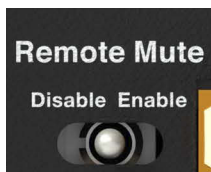

Figure 18: Remote Mute Switch

- **Disable:** When the Remote Mute switch is set to Disable (to the left), the loudspeaker cannot be muted or soloed from Compass RMS.
- **Enable:** When the Remote Mute switch is set to Enable (to the right), the loudspeaker can be muted and soloed from Compass RMS.



NOTE: Compass RMS also allows you to disable Mute and Solo functions to eliminate any possibility of accidentally muting loudspeakers.

RMS Network Connectors

The Weidmuller 2-conductor, locking connectors transfer data to and from the RMS network. Two connectors are

provided to allow for easy connection of multiple (daisy-chained) loudspeakers on the network. Included with each RMS-equipped loudspeaker are RMS cable connectors and mounting blocks for constructing RMS cables. The RMS blocks allow the Weidmuller connectors to be securely attached to the RMS module with screws.

NEURON ID FOR RMS MODULE

Each RMS module has a unique 12-character Neuron ID (NID) that identifies the loudspeaker on the network. The NID is automatically detected by RMServer but can also be entered manually, if necessary, when configuring RMS systems in Compass RMS without loudspeakers present. The NID label is located on the RMS user panel near the orange Network connectors.

RESETTING THE RMS MODULE

Use the Identify button to reset the Ultra Reflex LF-18 RMS module when powering on the loudspeaker. This action will cause the module to be removed from the RMS network.

To reset the RMS module:

1. Power down the loudspeaker.
2. Press and hold the Identify button.
3. While continuing to hold down the Identify button, power on the loudspeaker.
4. After the Wink/Status LED flashes on and off, release the Identify button. The RMS module is reset and the loudspeaker is removed from the RMS network.

ULTRA REFLEX LF-18 SPECIFICATIONS

Ultra Reflex LF-18 Specifications

ACOUSTICAL	
Linear Peak SPL	<p>133 dB with crest factor >10 dB (M-noise), 133 dB (Pink Noise), 134.5 dB (B-noise)</p> <p>Note: Linear Peak SPL is measured in half-space at 4 m referred to 1 m. Loudspeaker SPL compression measured with M-noise at the onset of limiting, 2-hour duration, and 50 °C ambient temperature is <2 dB.</p> <p>M-noise is a full bandwidth (10 Hz–22.5 kHz) test signal developed by Meyer Sound to better measure the loudspeaker’s music performance. It has a constant instantaneous peak level in octave bands, a crest factor that increases with frequency, and a full bandwidth Peak to RMS ratio of 18 dB. The presence of a greater-than (>) symbol with regard to crest factor indicates it may be higher depending on EQ and boundary loading.</p> <p>Pink noise is a full bandwidth test signal with Peak to RMS ratio of 12.5 dB.</p> <p>B-noise is a Meyer Sound test signal used to ensure measurements reflect system behavior when reproducing the most common input spectrum, and to verify there is still headroom over pink noise.</p>
COVERAGE	
	360° (single loudspeaker); varies with number of loudspeakers and configurations
TRANSDUCERS	
Low Frequency	One 18-inch dual-coil, long-excursion cone driver; 2 Ω nominal impedance
AUDIO INPUT	
Type	Differential, electronically balanced
Maximum Common Mode Range	±15 V DC, clamped to earth for voltage transient protection
Connectors	XLR 3-pin female with male loop output
Input Impedance	10 kΩ differential between pins 2 and 3
Wiring	<p>Pin 1: Chassis/earth through 1 kΩ, 1000 pF, 15 V clamped network to provide virtual ground lift at audio frequencies</p> <p>Pin 2: Signal (+)</p> <p>Pin 3: Signal (-)</p> <p>Case: Earth ground and chassis</p>
Nominal Input Sensitivity	6.0 dBV (2.0 V rms) continuous is typically the onset of limiting for noise and music
Input Level	Audio source must be capable of producing +20 dBV (10 V rms) into 600 Ω to produce the maximum peak SPL over the operating bandwidth of the loudspeaker
AMPLIFIER	
Type	Two-channel, open-loop, class D
Total Output Power	<p>3100 W peak</p> <p>Note: Peak power based on the maximum unclipped voltage the amplifier will produce into the nominal load impedance.</p>
THD, IM, TIM	< 0.02%
Cooling	Convection

Ultra Reflex LF-18 Specifications

AC POWER			
Connectors	PowerCON 20 input with loop output		
Automatic Voltage Selection	90–265 V AC, 50–60 Hz		
Safety Agency Rated Voltage Range	100–240 V AC, 50–60 Hz		
Turn-on/off Points	Turn-on: 90 V AC; Turn-off: none; internal fuse protection above 265 V AC		
CURRENT DRAW			
Idle	0.60 A rms (115 V AC)	0.49 A rms (230 V AC)	0.63 A rms (100 V AC)
Maximum Long-Term Continuous (> 10 sec)	4.9 A rms (115 V AC)	2.5 A rms (230 V AC)	5.2 A rms (100 V AC)
Burst (< 1 sec)	8.8 A rms (115 V AC)	4.7 A rms (230 V AC)	11.0 A rms (100 V AC)
	Note: AC power cabling must be of sufficient gauge so that under burst rms current conditions, cable transmission losses do not cause the loudspeaker's voltage to drop below the specified operating range.		
Maximum Instantaneous Peak	18.2 A peak (115 V AC)	9.2 A peak (230 V AC)	20.6 A peak (100 V AC)
Inrush	< 20 A peak		
RMS NETWORK			
	Equipped with two-conductor twisted-pair network module that reports all operating parameters of amplifiers to system operator's host computer via the RMServer™ hardware unit, which must be purchased separately.		
PHYSICAL			
Enclosure	Premium multi-ply birch with slightly textured black finish		
Protective Grille	Powder-coated, hex-stamped steel with acoustical black mesh		
Rigging	Optional MRK-900 rigging kit that has endframes with captive GuideALinks secured with 5/16-inch x 0.63-inch black button quick release pins that allow 0°, 1.25°, 2.5°, 3.75°, or 5° splay angles; detachable side handles. Rigging supports ground-stacked and flown configurations.		
Pole Mount	U.S. version: 1.5 in (38 mm) E.U. version: 1.375 in (35 mm and M20 thread at the bottom)		
Load Ratings	MG-LEOPARD/900 multipurpose grid flies 17 Ultra Reflex LF-18s at a 5:1 safety factor, with some restrictions		
Dimensions	27.43 in (697 mm) W	24.43 in (621 mm) H	24.89 in (632 mm) D
Dimensions (w/Rigging)	27.47 in (698 mm) W	24.43 in (621 mm) H	24.89 in (632 mm) D
Dimensions (w/Rigging and Rain Hood)	27.47 in (698 mm) W	24.43 in (621 mm) H	28.55 in (725 mm) D
Weight	136 lb (61.7 kg)		
Weight (w/Rigging)	159 lb (72.1 kg)		
Weight (UW version)	167 lb (75.8 kg)		
ENVIRONMENTAL			
Operating Temperature	0 °C to +45 °C		Pending UL, CE & RCM 
Non Operating Temperature	–40 °C to +75 °C		
Humidity	To 95% at 45 °C (non-condensing)		
Operating Altitude	To 5,000 m (16,404 ft)		
Non Operating Altitude	To 12,000 m (39,000 ft)		
Shock	30 g 11 msec half-sine on each of 6 sides		
Vibration	10 Hz – 55 Hz (0.010 m peak-to-peak excursion)		

ULTRA REFLEX LF-18 DIMENSIONS

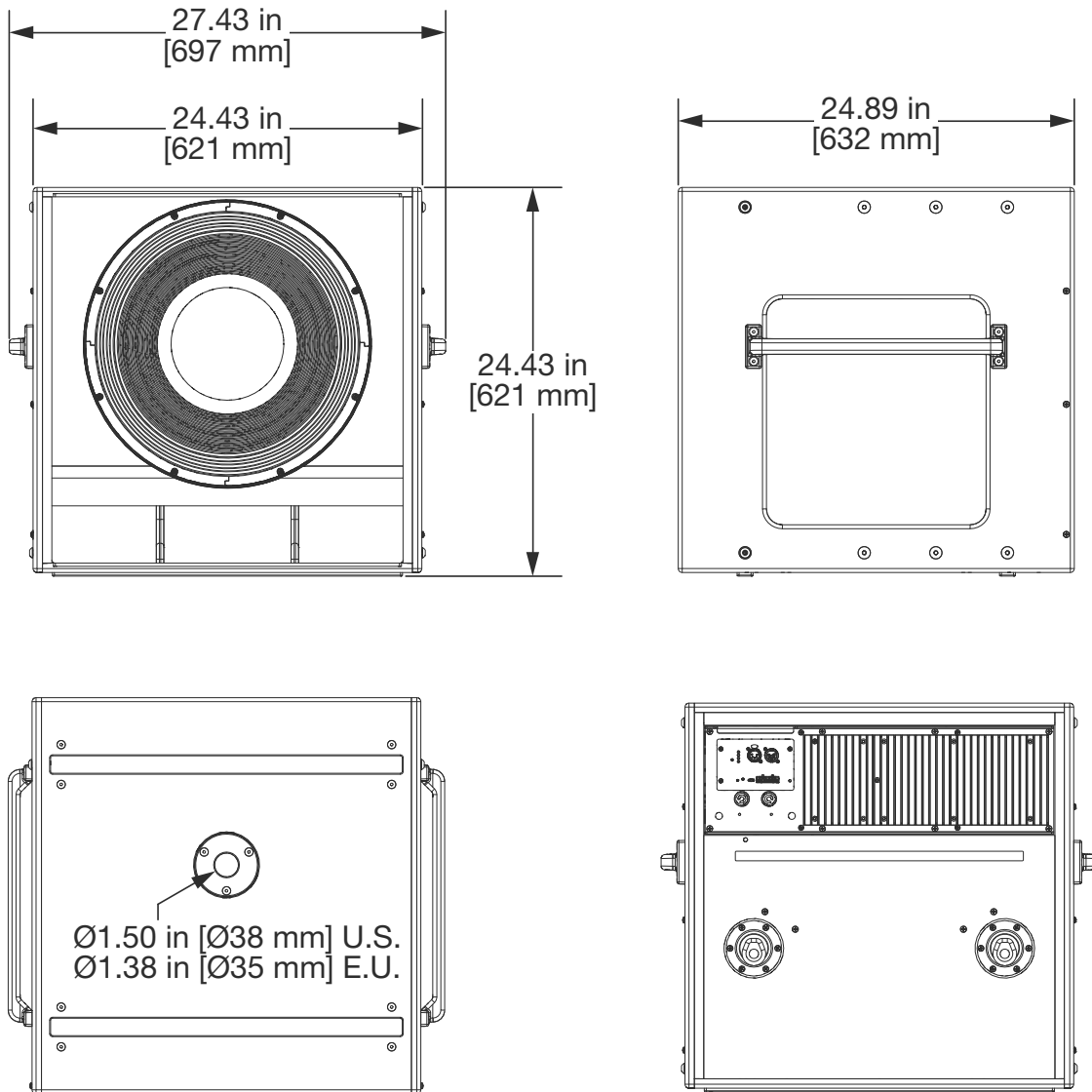

Figure 19: Ultra Reflex LF-18 Loudspeaker Dimensions without Rigging



NOTE: For dimensions and weight for the MG-LEOPARD top grid and MCF-900 caster frame, refer to the MG-LEOPARD/900 Assembly Guide (PN 05.243.080.01) available at meyersound.com/documents.

ULTRA REFLEX LF-18 WITH RIGGING DIMENSIONS

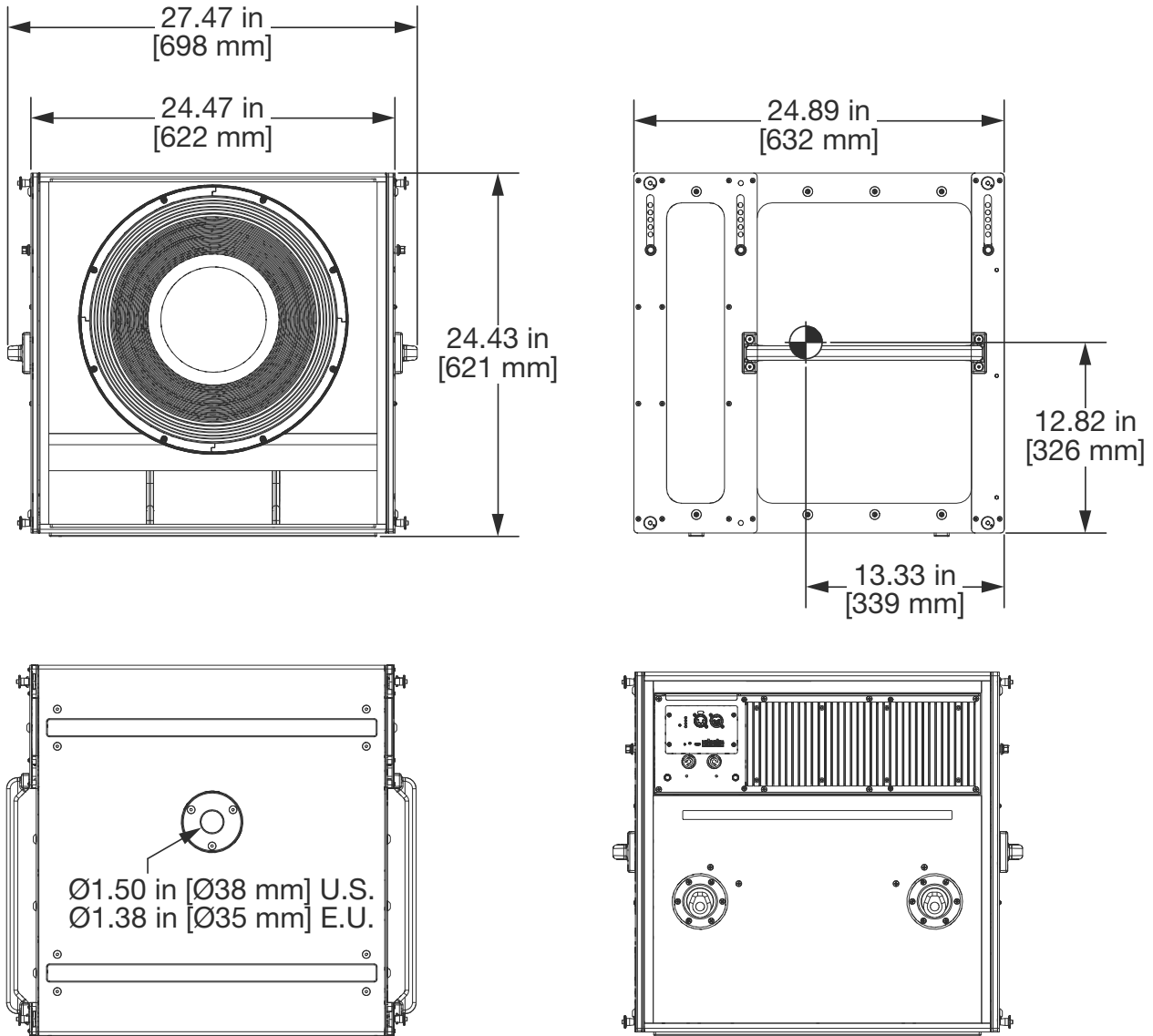

Figure 20: Ultra Reflex LF-18 Loudspeaker Dimensions with Rigging



THINKING SOUND

Meyer Sound Laboratories, Incorporated.
2832 San Pablo Avenue
Berkeley, CA 94702
+1 510 486.1166
meyersound.com

© 2021
Meyer Sound Laboratories, Incorporated. All rights reserved.
Ultra Reflex LF-18 Operating Instructions
PN 05.312.005.01 A